

Knobs &  
handles  
catalogue

2024

[pedenetti.com](https://pedenetti.com)

Made to

STAND  
OUT

20  
24

 pedenetti



**Handles & knobs  
catalogue**

[www.pedenetti.com](http://www.pedenetti.com) 

# MADE TO STAND OUT

eng

## A charismatic personality

The personality of our collection of knobs and handles for 2024 stands out for many different reasons: for their daring character; for their creative rebelliousness; and for shaking the foundations of everything that we have designed until now. It's a new beginning.

We have maximized features and aesthetics. The handles with larger dimensions have become more forceful with big diameters which allow them to be used in new ways thanks to the "back to back" format which means they can be fitted on both sides of the door. They stand out for their natural look which is why we created them. The organic spirit of wood can be found in the details which make the difference, whilst the new finishes flood your interiors with a special charisma. All of our designs are really surprising as they are full of freedom.

esp

## Personalidad carismática

La personalidad de nuestra nueva colección de pomos y tiradores 2024 destaca por muchos motivos: por su carácter atrevido; por su rebeldía creativa; y por sacudir los cimientos de todo lo que hemos diseñado hasta ahora. Es un punto y aparte.

Estética y prestaciones se maximizan. Los tiradores de grandes dimensiones aumentan su contundencia con diámetros "big" y permiten nuevas formas de uso gracias al formato "back to back" que hace posible instalarlos a ambos lados de las puertas. Sobresalen con naturalidad, forma parte de su esencia.

El espíritu orgánico de la madera se propaga en detalles que marcan la diferencia, mientras nuevos acabados inundan los interiorismos de un carisma especial. Todos los diseños sorprenden, porque están llenos de libertad.



# FROM PEDENETTI *around the world*

eng ———

## **Singular products for plural tastes**

Interior design professionals and architects from all around the world trust in our products for their projects, and of course individual customers. At Pedenetti they can find a wide variety of eclectic, decorative accessories which adapt to different tastes and lifestyles. Our designs transform all types of spaces and transmit the personality of whoever lives in that space.

esp ———

## **Productos singulares para gustos plurales**

Profesionales del interiorismo y la arquitectura de todo el mundo confían en nuestros productos para sus proyectos. Y también particulares, por supuesto. En Pedenetti encuentran una amplia variedad de complementos decorativos eclécticos que se adaptan a los diferentes gustos y estilos de vida. Nuestros diseños transforman todo tipo de espacios y transmiten la personalidad de quienes los habitan.

# OUT STANDING *Designers*

eng \_\_\_\_\_

## **Challenging the conventional**

We have the privilege of designing in Europe, collaborating with designers from all over the world who help us to go that little step further. Together we explore new horizons in decorative accessories. We make a fusion of shapes, materials and trends. We challenge the conventional to create the unexpected.

esp \_\_\_\_\_

## **Desafiamos lo convencional**

Tenemos el privilegio de diseñar desde Europa en colaboración con diseñadores de todo el mundo que nos llevan a ir un paso más allá. Juntos exploramos nuevos horizontes en accesorios decorativos. Fusionamos formas, materiales y tendencias. Desafiamos lo convencional para crear lo inesperado.

**ALEXIS VIVET** / Spain  
**BALUTTO ASSOCIATI** / Italy  
**FRANK PERSON** / Germany  
**HÉCTOR DIEGO** / Spain  
**ILJA HUBER** / Germany  
**KASCHKASCH** / Germany  
**PATRICIA ROIG** / Spain  
**TERUEL-PARÉ** / Spain  
**VIEFE STUDIO** / Spain  
**2J DESIGN** / USA



# *we love* **NATURE**

eng ———

## **Going for green**

Each and every year we make further advances towards being more sustainable. The presence of wood in our products is ever increasing, we can certify its origins, as with the rest of our materials. The majority of our packaging is paper based and we have significantly reduced our use of non-recycled plastics. What's more, we are now working with 100% renewable energy and we also have the ISO 14001 certificate. We are taking action so that the natural environment that surrounds us tomorrow is just as green as that which surrounds us today.

esp ———

## **Apostamos por lo verde**

Cada año avanzamos para ser más sostenibles. La presencia de la madera en nuestros productos es cada vez mayor, podemos certificar su origen y también el del resto de materiales. Utilizamos packaging mayoritariamente de papel y hemos reducido al máximo los plásticos no reciclados. Además, funcionamos 100% con energías renovables y disponemos de la ISO 14001. Actuamos para que el entorno natural que nos rodee mañana sea tan verde como el de hoy.

—————  
*This is our HOME*



# OUR *Products*

—  
Nuestros  
productos



0636

# POINT

ALUMINIUM

Designer: Patricia Roig

**NEW!**

## Finishes

### Acabados

Brushed black  
*Negro cepillado*

Titanium black  
*Negro titanio*

Brushed brass cava  
*Latón cava cepillado*

←→ |    o — o 1    o — o 2

Ø 40 mm    -    -

110 mm    -    -

228 mm    192 mm    -

356 mm    320 mm    -

996 mm    960 mm    480mm

Includes non-twisting tip /  
*Incluye punta anti-giro*



Technical info on page 288  
*Info técnica en pág 288*







0636

**POINT**

ALUMINIUM

Designer: Patricia Roig

**NEW!**





0627

# FUSION

ZAMAK

Designer: Ilja Huber

**NEW!**

**Finishes**  
**Acabados**

Titanium black  
*Negro titanio*

Brushed brass cava  
*Latón cava cepillado*

Matt black  
*Negro mate*



←→	o — o	
58 mm	-	
180 mm	160 mm	
340 mm	320 mm	

Includes non-twisting tip  
*Incluye punta anti-giro*



Technical info on page 288  
*Info técnica en pág 288*



0627

# FUSION

ZAMAK

Designer: Ilja Huber

**NEW!**



←→	o — o	
58 mm	-	Includes non-twisting tip
180 mm	160 mm	Incluye punta anti-giro
340 mm	320 mm	

### Finishes Acabados

Polished titanium black  
*Titanio negro brillo*

Polished nickel  
*Níquel brillo*

Polished brass  
*Latón brillo*

⊕  
Technical info on page 288  
*Info técnica en pág 288*



0635

**LIDD**

ZAMAK

Designer: Ilja Huber

**NEW!**

**Finishes**  
**Acabados**

Brushed nickel  
*Níquel cepillado*

Titanium black  
*Negro titanio*

Brushed brass cava  
*Latón cava cepillado*

Matt white  
*Blanco mate*

Matt black  
*Negro mate*

∅  
64 mm



⊕  
Technical info on page 289  
*Info técnica en pág 289*



0638

**PRISM**

ZAMAK

Designer: Patricia Roig

**NEW!**



**Finishes**  
**Acabados**

Titanium black  
*Negro titanio*

Brushed brass cava  
*Latón cava cepillado*

Matt white  
*Blanco mate*

Matt black  
*Negro mate*

Polished titanium black  
*Titanio negro brillo*

Polished nickel  
*Níquel brillo*

Polished brass  
*Latón brillo*



32 mm

Includes non-twisting tip  
*Incluye punta anti-giro*



Technical info on page 289  
*Info técnica en pág 289*



0643

**LINKK**

ALUMINIUM

Designer: Alexis Vivet

**NEW!**

**Finishes**  
**Acabados**

Stainless steel look  
*Inox look*

Brushed brass  
*Latón cepillado*

Brushed black  
*Negro cepillado*

←→	o — o 1	o — o 2
175 mm	160 mm	-
335 mm	320 mm	-
1071 mm	1056 mm	528 mm

⊕  
Technical info on page 290  
*Info técnica en pág 290*





0643

**LINKK**

ALUMINIUM

Designer: Alexis Vivet

**NEW!**





0648

**OMEGA**

ZAMAK

Designer: Kaschkasch

**NEW!**

**Finishes**  
**Acabados**

Brushed brass cava  
*Latón cava cepillado*

Rustic brass  
*Latón rústico*

Matt black  
*Negro mate*



←→	○ — ○
62,5 mm	32 mm
190,5 mm	160 mm

⊕  
Technical info on page 290  
*Info técnica en pág 290*





0650

# MOULE

ZAMAK

Designer: Kaschkasch

**NEW!**

## Finishes

### Acabados

Titanium black  
*Negro titanio*

Brushed brass cava  
*Latón cava cepillado*

Matt white  
*Blanco mate*

Matt black  
*Negro mate*

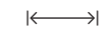

154 mm

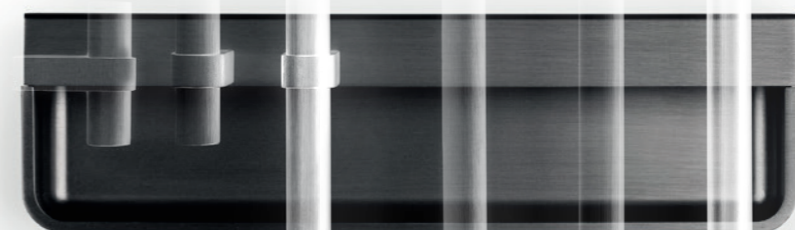

Technical info on page 291  
*Info técnica en pág 291*



0603

**LIPP**

ZAMAK

Designer: Alexis Vivet

**NEW!**



**Finishes**  
**Acabados**

Brushed brass cava  
*Latón cava cepillado*

Matt black  
*Negro mate*

←→	o — o
205 mm	192 mm
333 mm	320 mm

⊕  
Technical info on page 291  
*Info técnica en pág 291*



0645

**RISS mini**

ALUMINIUM

Designer: Kaschkasch

**NEW!**

**Finishes**  
**Acabados**

Matt white  
*Blanco mate*

Matt black  
*Negro mate*

Moss grey  
*Gris musgo*

Forest green  
*Verde forest*

Mocca brown  
*Marrón mocca*

Volcano red  
*Rojo volcano*

Midnight blue  
*Azul midnight*



Technical info on page 292  
*Info técnica en pág 292*



←→	o — o	∅
207 mm	192 mm	15 mm
335 mm	320 mm	15 mm



0655

# RISS big

ALUMINIUM

Designer: Kaschkasch

NEW!

## Finishes Acabados

Matt white  
*Blanco mate*

Matt black  
*Negro mate*

Moss grey  
*Gris musgo*

Forest green  
*Verde forest*

Mocca brown  
*Marrón mocca*

Volcano red  
*Rojo volcano*

Midnight blue  
*Azul midnight*



←→	o — o 1	o — o 2	∅
502 mm	480 mm	-	20 mm
982 mm	960 mm	480 mm	20 mm



Technical info on page 292  
*Info técnica en pág 292*



0657

**NOBB**

ALUMINIUM

Designer: Viefe Studio

**NEW!**

←→	o — o 1	o — o 2	
52 mm	-	-	Includes non-twisting tip / Incluye punta anti-giro
244 mm	192 mm	-	
372 mm	320 mm	-	
1108 mm	1056 mm	528mm	

**Finishes**  
**Acabados**

Stainless steel look  
*Inox look*

Brushed brass cava  
*Latón cava cepillado*

Brushed black  
*Negro cepillado*



Technical info on page 293  
*Info técnica en pág 293*



0657

**NOBB**

ALUMINIUM

Designer: Viefe Studio

**NEW!**

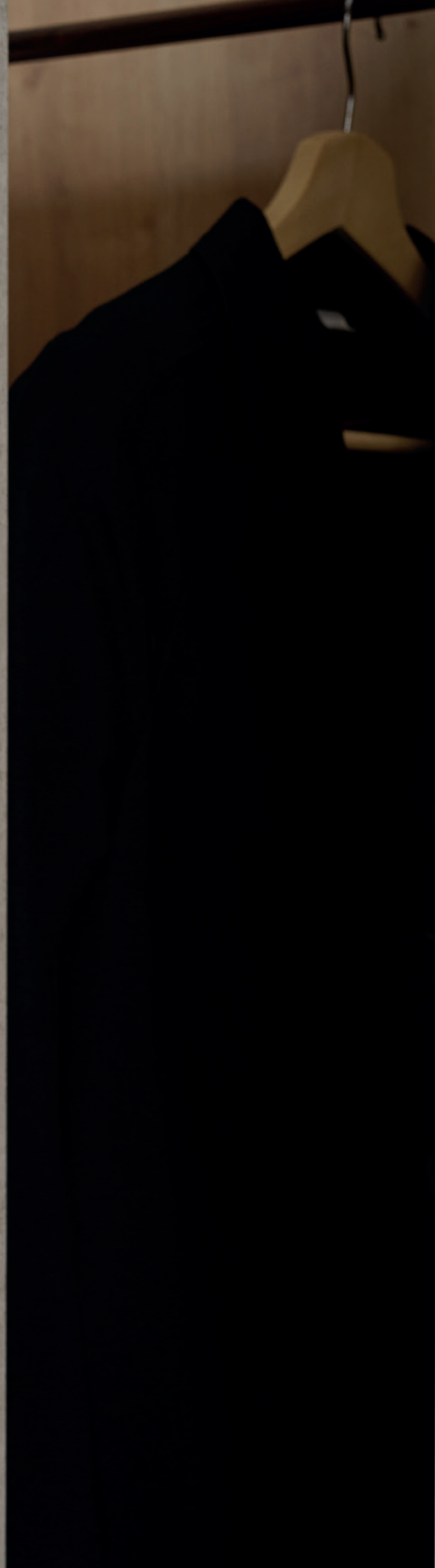

0629 / 0662 / 0663

**MOON**

ALUMINIUM

Designer: Ilja Huber

**NEW!**

**Finishes**  
**Acabados**

Stainless steel look  
*Inox look*

Brushed brass cava  
*Laton cava cepillado*

Brushed black  
*Negro cepillado*



		
424 mm	384 mm	-
1096 mm	1056 mm	528 mm

 Available with one side system  
*Disponible con sistema de una cara*

 Available with back to back system  
*Disponible con sistema de doble cara*

 Technical info on page 293  
*Info técnica en pág 293*

0629 / 0662 / 0663

**MOON**

ALUMINIUM

Designer: Ilja Huber

**NEW!**







0658

# DUO mini

ALUMINIUM + WOOD

Designer: Ilja Huber

NEW!



### Finishes Acabados

- Lava grey + Oak  
 Gris lava + Roble
- Lava grey + Walnut  
 Gris lava + Nogal
- Matt black +  
 Oak matt black lacquered  
 Negro mate +  
 Roble lacado negro mate

K →	o — o
194,6 mm	160 mm
354,6 mm	320 mm

Certified wood  
 Madera certificada

Technical info on page 294  
 Info técnica en pág 294

0659 / 0668 / 0670

## DUO big

ALUMINIUM + WOOD

Designer: Ilja Huber

NEW!

### Finishes Acabados

- 🌿 Lava grey + Oak  
*Gris lava + Roble*
- Lava grey + Walnut  
*Gris lava + Nogal*
- 🌿 Matt black +  
Oak matt black lacquered  
*Negro mate +  
Roble lacado negro mate*

←→	o — o 1	o — o 2
536 mm	480 mm	-
1016 mm	960 mm	480 mm



Certified wood  
*Madera certificada*



Available with one side system  
*Disponible con sistema de una cara*



Available with back to back system  
*Disponible con sistema de doble cara*



Technical info on page 294  
*Info técnica en pág 294*

0664 / 0665 / 0671



# LUV WOOD



WOOD

Designer: Kaschkasch

**NEW!**

### Finishes Acabados

-  Oak  
Roble
- Walnut  
Nogal
-  Oak matt black lacquered  
Roble lacado negro mate

	 1	 2
418,5 mm	384 mm	-
1026,5 mm	992 mm	496 mm



 Certified wood  
Madera certificada

 Available with one side system  
Disponible con sistema de una cara

 Available with back to back system  
Disponible con sistema de doble cara

 Technical info on page 295  
Info técnica en pág 295

0664 / 0665 / 0671

**LUV WOOD**

WOOD

Designer: Kaschkasch

**NEW!**





0536

**LUV**

ZAMAK

Designer: Kaschkasch

**Finishes**  
**Acabados**

	←→	o — o
Brushed nickel <i>Níquel cepillado</i>	51,2 mm	-
Brushed brass cava <i>Latón cava cepillado</i>	202 mm	192 mm
	330 mm	320 mm

Includes non-twisting tip  
*Incluye punta anti-giro*

Matt white  
*Bianco mate*

Matt black  
*Negro mate*



Technical info on page 295  
*Info técnica en pág 295*



0621

**RILLE mini** ALUMINIUM

Designer: Patricia Roig

**NEW!**

**Finishes**  
**Acabados**

Polished nickel  
*Níquel brillo*

Stainless steel look  
*Inox look*

Brushed brass  
*Latón cepillado*

Brushed black  
*Negro cepillado*

←→	o — o
55 mm	-
190 mm	160 mm
350 mm	320 mm

Includes non-twisting tip  
*Incluye punta anti-giro*



Technical info on page 296  
*Info técnica en pág 296*



0528

**RILLE**

ALUMINIUM

Designer: Patricia Roig

**Finishes**  
**Acabados**

Stainless steel look  
*Inox look*

Brushed brass  
*Latón cepillado*

Brushed black  
*Negro cepillado*



←→	o — o 1	o — o 2	
55 mm	-	-	Includes non-twisting tip <i>Incluye punta anti-giro</i>
190 mm	160 mm	-	
350 mm	320 mm	-	
510 mm	480 mm	-	
1022 mm	992 mm	496 mm	

⊕  
Technical info on page 296  
*Info técnica en pág 296*



0487

PURA

ZAMAK

Designer: Balutto Associati

**Finishes**  
**Acabados**

Polished chrome  
*Cromo brillo*

Polished titanium black  
*Titanio negro brillo*

Polished copper  
*Cobre brillo*

Polished brass  
*Latón brillo*

**NEW!** Brushed nickel  
*Níquel cepillado*

**NEW!** Brushed brass cava  
*Latón cava cepillado*

**NEW!** Matt black  
*Negro mate*

←→ |      o — o

168 mm      160 mm

**NEW!** 264 mm      256 mm

⊕  
Technical info on page 297  
*Info técnica en pág 297*

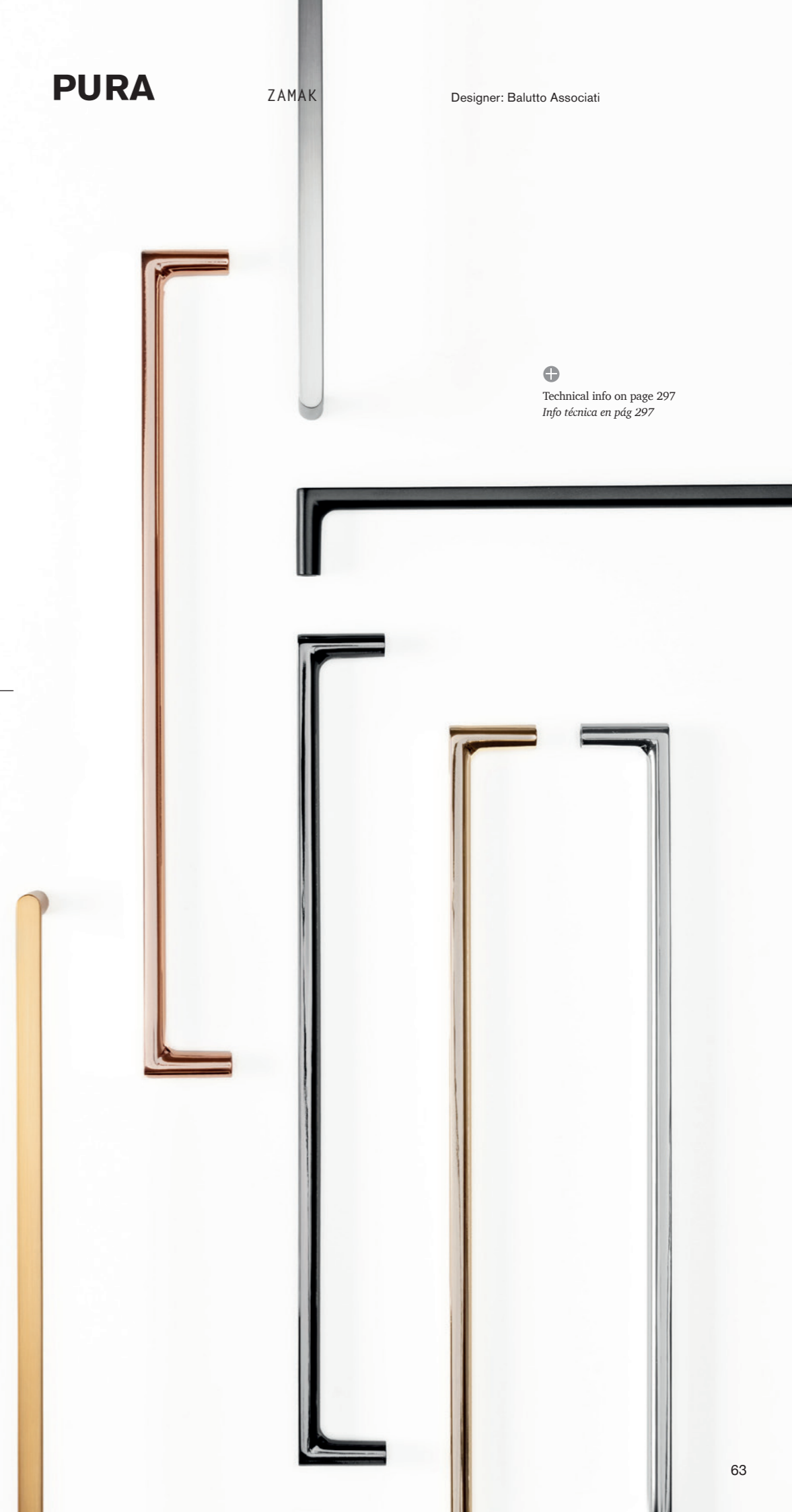





0487

**PURA**

ZAMAK

Designer: Balutto Associati





0590

# BELT

ZAMAK

Designer: Kaschkasch



## Finishes Acabados

Matt white  
*Blanco mate*

Matt black  
*Negro mate*

Moss grey  
*Gris musgo*

Forest green  
*Verde forest*

Mocca brown  
*Marrón mocca*

Volcano red  
*Rojo volcano*

←→	o — o	Includes non-twisting tip <i>Incluye punta anti-giro</i>
63,5 mm	-	
221,3 mm	160 mm	

⊕  
Technical info on page 297  
*Info técnica en pág 297*



0590

# BELT

ZAMAK

Designer: Kaschkasch

**Finishes**  
**Acabados**

Matt white  
*Blanco mate*

Matt black  
*Negro mate*

Moss grey  
*Gris musgo*

Forest green  
*Verde forest*

Mocca brown  
*Marrón mocca*

Volcano red  
*Rojo volcano*

↳	↳	○	○
63,5 mm	-	Includes non-twisting tip <i>Incluye punta anti-giro</i>	
221,3 mm	-	160 mm	



⊕  
Technical info on page 297  
*Info técnica en pág 297*



0597

**PLIÉ**

ZAMAK

Designer: Teruel & Paré

**Finishes**  
**Acabados**

Matt black  
*Negro mate*

Metal grey  
*Gris metal*

Metal brown  
*Marrón metal*

◀—▶	○ — ○
114 mm	64 mm
210 mm	160 mm



⊕  
Technical info on page 298  
*Info técnica en pág 298*



0600

**WING**

ALUMINIUM

Designer: Alexis Vivet

**Finishes**

**Acabados**

Stainless steel look  
*Inox look*

Brushed black  
*Negro cepillado*

Antique bronze  
*Bronce antiguo*

Brushed brass cava  
*Latón cava cepillado*

↳ — ◁

○ — ○ 1

○ — ○ 2

100 mm

64 mm

-

200 mm

128 mm

-

350 mm

256 mm

-

1200 mm

1120 mm

384 mm



Technical info on page 298  
*Info técnica en pág. 298*

0600

**WING**

ALUMINIUM

Designer: Alexis Vivet





0610

**FLAPP**

ALUMINIUM

Designer: Frank Person

**Finishes**  
**Acabados**

Stainless steel look  
*Inox look*

Brushed black  
*Negro cepillado*

Brushed brass cava  
*Latón cava cepillado*

	←→	o — o 1	o — o 2
Stainless steel look <i>Inox look</i>	70 mm	32 mm	-
Brushed black <i>Negro cepillado</i>	200 mm	128 mm	160 mm
Brushed brass cava <i>Latón cava cepillado</i>	350 mm	256 mm	-
	1100 mm	416 mm	1056 mm



Technical info on page 299  
*Info técnica en pág 299*



0610

**FLAPP**

ALUMINIUM

Designer: Frank Person







0613

**FLAPP**

WOOD

Designer: Frank Person



**Finishes**  
**Acabados**

Oak  
*Roble*

Walnut  
*Nogal*

Oak raw  
*Roble crudo*

←→	o — o 1	o — o 2
70 mm	32 mm	-
200 mm	160 mm	-
1100 mm	1056 mm	416 mm



Technical info on page 300  
*Info técnica en pág. 300*





0613

**FLAPP**

WOOD

Designer: Frank Person





0591

**ETO**

ALUMINIUM + WOOD

Designer: Kaschkasch



Technical info on page 299  
 Info técnica en pág 299



**Finishes**  
**Acabados**

Lava grey + Oak  
 Gris lava + roble

Lava grey + Walnut  
 Gris lava + Nogal

Matt black + Ash matt black lacquered  
 Negro mate + Fresno lacado negro mate

←→	o — o 1	o — o 2
174,6 mm	160 mm	-
334,6 mm	320 mm	-
1006,6 mm	992 mm	496 mm



0591

**ETO**

ALUMINIUM + WOOD

Designer: Kaschkasch



0601

**OH!**

WOOD

Designer: Alexis Vivet

**Finishes**  
**Acabados**

---

Oak  
*Roble*

Walnut  
*Nogal*

Ash matt black lacquered  
*Fresno lacado negro mate*



40 mm



Technical info on page 300  
*Info técnica en pág. 300*



0601

**OH!**

ZAMAK

Designer: Alexis Vivet

**Finishes**  
**Acabados**

Brushed nickel  
*Níquel cepillado*

Brushed brass cava  
*Latón cava cepillado*

Matt black  
*Negro mate*



40 mm



Technical info on page 301  
*Info técnica en pág. 301*



0602

**VALLEY**

ZAMAK

Designer: Alexis Vivet

**Finishes**  
**Acabados**

Polished titanium black  
*Titanio negro brillo*

Polished brass  
*Latón brillo*

Matt black  
*Negro mate*

Brushed brass cava  
*Latón cava cepillado*

K → I	o — o
223 mm	160 mm
330 mm	256 mm



⊕  
Technical info on page 301  
*Info técnica en pág. 301*



0602

**VALLEY**

ZAMAK

Designer: Alexis Vivet



**Finishes**  
**Acabados**

Polished titanium black  
*Titanio negro brillo*

Polished brass  
*Latón brillo*

Matt black  
*Negro mate*

Brushed brass cava  
*Latón cava cepillado*

←→	○ — ○
223 mm	160 mm
330 mm	256 mm

⊕  
Technical info on page 301  
*Info técnica en pág. 301*





0614

**EQUIS**

ZAMAK

Designer: Patricia Roig



**Finishes**  
**Acabados**

Polished chrome  
*Cromo brillo*

Polished titanium black  
*Titanio negro brillo*

Polished copper  
*Cobre brillo*

Polished brass  
*Latón brillo*

Matt white  
*Blanco mate*

Matt black  
*Negro mate*

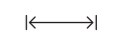

40 mm



Technical info on page 302  
*Info técnica en pág 302*



0604

**PRISMA**

ZAMAK

Designer: Alexis Vivet



**Finishes**  
**Acabados**

Matt black  
*Negro mate*

Rustic brass  
*Latón rústico*

↳ —	o — o	
78 mm	-	Includes non-twisting tip <i>Incluye punta anti-giro</i>
272 mm	192 mm	



Technical info on page 301  
*Info técnica en pág 301*



0608

# QUART mini

ZAMAK

Designer: Frank Person

**Finishes**  
**Acabados**

Brushed brass cava  
*Latón cava cepillado*

Rustic brass  
*Latón rústico*

Matt black  
*Negro mate*

←→	o — o	
26 mm	-	Includes non-twisting tip <i>Incluye punta anti-giro</i>
146 mm	128 mm	



⊕  
Technical info on page 302  
*Info técnica en pág. 302*



0616

## QUART big

ZAMAK

Designer: Frank Person



### Finishes Acabados

Brushed brass cava  
*Latón cava cepillado*

Rustic brass  
*Latón rústico*

Matt black  
*Negro mate*

←→	o — o	
33,8 mm	-	Includes non-twisting tip <i>Incluye punta anti-giro</i>
183,4 mm	160 mm	

⊕  
Technical info on page 302  
*Info técnica en pág 302*



0588

# ARPA PLATE

ALUMINIUM

Designer: Viefe Studio

**Finishes**  
**Acabados**

Rustic brass  
*Latón rústico*

←→	o — o
Ø 22 mm	
70 mm	-
230 mm	192 mm



⊕  
Technical info on page 306  
*Info técnica en pág 306*

0588

# ARPA PLATE

ALUMINIUM

Designer: Viefe Studio

### Finishes

#### Acabados

	←→	o — o 1	o — o 2
Stainless steel look <i>Inox look</i>	Ø 22 mm	-	-
	70 mm	-	-
Brushed brass <i>Latón cepillado</i>	230 mm	192 mm	-
	358 mm	320 mm	-
Brushed black <i>Negro cepillado</i>	1216 mm	1178 mm	589 mm



Technical info on page 306  
Info técnica en pág 306

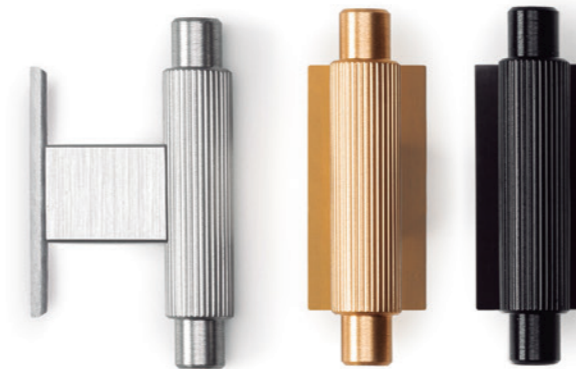



0583

**ARPA**

ALUMINIUM

Designer: Viefe Studio

**Finishes**  
**Acabados**

Rustic brass  
*Latón rústico*

↳ |    ◦ — ◦

Ø 22 mm -

70 mm -

214 mm

- Includes non-twisting tip  
*Incluye punta anti-giro*



⊕  
Technical info on page 307  
*Info técnica en pág 307*



0583

**ARPA**

ALUMINIUM

Designer: Viefe Studio

**Finishes**  
**Acabados**

Stainless steel look  
*Inox look*

Brushed brass  
*Latón cepillado*

Brushed black  
*Negro cepillado*

←→	o — o 1	o — o 2	
Ø 22 mm	-	-	
70 mm	-	-	Includes non-twisting tip <i>Incluye punta anti-giro</i>
214 mm	192 mm	-	
342 mm	320 mm	-	
1200 mm	1178 mm	589 mm	



⊕  
Technical info on page 307  
*Info técnica en pág 307*



0583

**ARPA**

ALUMINIUM

Designer: Viefe Studio





0506

**FIRM**

ZAMAK

Designer: Frank Person



**Finishes**  
**Acabados**

Textured black  
*Negro texturizado*

←→ |    o — o

45,8 mm    -

93,8 mm    64 mm

93,8 mm    64 mm    *Cup pull / Tirador concha*

125,8 mm    96 mm

189,8 mm    160 mm

349,8 mm    320 mm



Technical info on page 315

*Info técnica en pág 315*



0506

**FIRM**

ZAMAK

Designer: Frank Person



0506

**FIRM**

ZAMAK

Designer: Frank Person

**Finishes**  
**Acabados**

Textured black  
*Negro texturizado*

←→	o — o
45,8 mm	-
93,8 mm	64 mm
93,8 mm	64 mm <i>Cup pull / Tirador concha</i>
125,8 mm	96 mm
189,8 mm	160 mm
349,8 mm	320 mm



⊕  
Technical info on page 315  
*Info técnica en pág 315*



0530

**DISC**

WOOD

Designer: Balutto Associati



**Finishes**  
**Acabados**

Oak  
*Roble*

Walnut  
*Nogal*

Ash matt black lacquered  
*Fresno lacado negro mate*



38 mm  
50 mm



Technical info on page 303  
*Info técnica en pág. 303*



0530

**DISC**

ZAMAK

Designer: Balutto Associati



**Finishes**  
**Acabados**

Brushed nickel  
*Níquel cepillado*

Brushed brass cava  
*Latón cava cepillado*

Matt white  
*Blanco mate*

Matt black  
*Negro mate*



38 mm  
50 mm



Technical info on page 303  
*Info técnica en pág. 303*



0538

**CONIC**

WOOD

Designer: Kaschkasch



**Finishes**  
**Acabados**

Oak  
*Roble*

Walnut  
*Nogal*

Ash matt black lacquered  
*Fresno lacado negro mate*



29,4 mm

43 mm



Technical info on page 303  
*Info técnica en pág. 303*



0538

**CONIC**

ZAMAK

Designer: Kaschkasch



**Finishes**  
**Acabados**

Matt white  
*Blanco mate*

Matt black  
*Negro mate*

Moss grey  
*Gris musgo*



29,4 mm

43 mm



Technical info on page 304  
*Info técnica en pág. 304*





0542

# FOLD

ZAMAK

Designer: Teruel & Paré

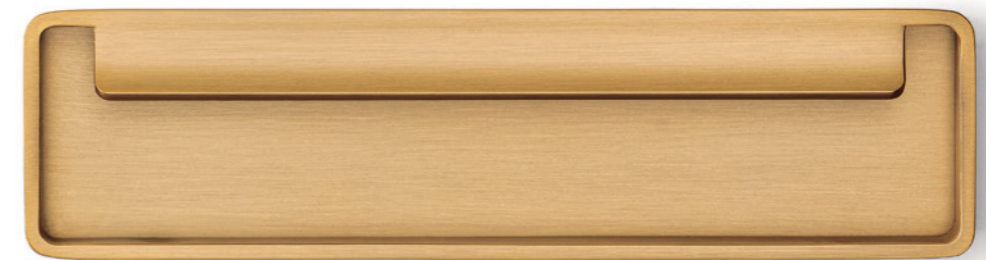
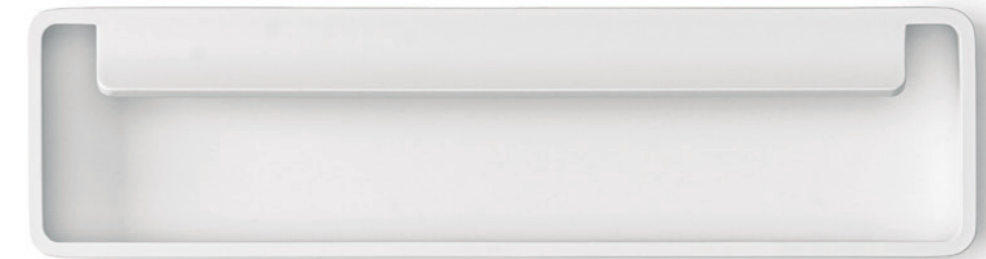

### Finishes Acabados

Brushed nickel  
*Níquel cepillado*

Brushed brass cava  
*Latón cava cepillado*

Matt white  
*Blanco mate*

Matt black  
*Negro mate*

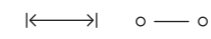

174 mm 128 mm



Technical info on page 306  
*Info técnica en pág 306*

0542

**FOLD**

ZAMAK

Designer: Teruel & Paré

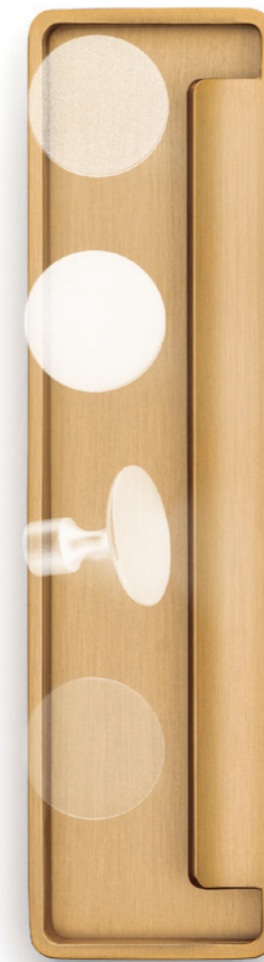

**Finishes**  
**Acabados**

Brushed nickel  
*Níquel cepillado*

Brushed brass cava  
*Latón cava cepillado*

Matt white  
*Blanco mate*

Matt black  
*Negro mate*

←→ |    o — o  
174 mm    128 mm

⊕  
Technical info on page 306  
*Info técnica en pág 306*



0543

**SOFT**

ZAMAK

Designer: Uli Budde



**Finishes  
Acabados**

	←→	o — o
Matt white <i>Blanco mate</i>	40 mm	32 mm
Matt black <i>Negro mate</i>	200 mm	192 mm
Moss grey <i>Gris musgo</i>	328 mm	320 mm

⊕  
Technical info on page 304  
Info técnica en pág 304



0552

**RIM**

ZAMAK

Designer: Bernat Lluch

**Finishes**  
**Acabados**

Brushed nickel  
*Níquel cepillado*

Brushed brass cava  
*Latón cava cepillado*

Matt white  
*Blanco mate*

Matt black  
*Negro mate*

Moss grey  
*Gris musgo*

←→ | ○ — ○  
120 mm | 96 mm

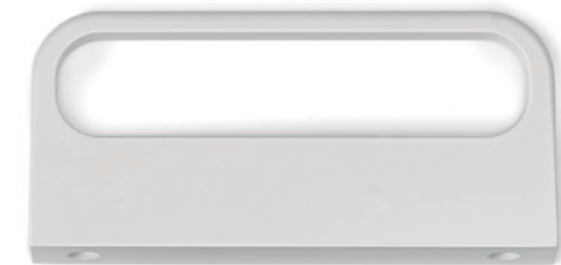

⊕  
Technical info on page 305  
*Info técnica en pág 305*



0553

**OTO**

ZAMAK

Designer: Bernat Lluch



**Finishes**  
**Acabados**

Black textured  
*Negro texturizado*

←→	o — o
60 mm	-
168 mm	128 mm

⊕  
Technical info on page 305  
*Info técnica en pág. 305*



0556

**DIPO**

ZAMAK

Designer: Bernat Llorch



**Finishes**  
**Acabados**

Matt white  
*Blanco mate*

Matt black  
*Negro mate*

Moss grey  
*Gris musgo*



74 mm



Technical info on page 304  
*Info técnica en pág. 304*



0372

**ONA**

ALUMINIUM

Designer: Teruel & Paré

**Finishes**  
**Acabados**

Stainless steel look  
*Inox look*

Brushed dark brass  
*Latón cepillado oscuro*

Brushed black  
*Negro cepillado*

Brushed grey  
*Gris cepillado*

Matt white  
*Blanco mate*

Metallic grey  
*Gris metal*

Metallic brown  
*Marrón metal*



←→	o — o 1	o — o 2
50 mm	32 mm	-
200 mm	128 mm	-
350 mm	256 mm	-
600 mm	544 mm	-
1100 mm	1056 mm	416 mm
1500 mm	1440 mm	480 mm



Technical info on page 326  
*Info técnica en pág. 326*



0372

**ONA**

ALUMINIUM

Designer: Teruel & Paré



**Finishes**  
**Acabados**

Stainless steel look  
*Inox look*

Brushed dark brass  
*Latón cepillado oscuro*

Brushed black  
*Negro cepillado*

Brushed grey  
*Gris cepillado*

Matt white  
*Blanco mate*

Metallic grey  
*Gris metal*

Metallic brown  
*Marrón metal*

←→	○ — ○ 1	○ — ○ 2
50 mm	32 mm	-
200 mm	128 mm	-
350 mm	256 mm	-
600 mm	544 mm	-
1100 mm	1056 mm	416 mm
1500 mm	1440 mm	480 mm

⊕  
Technical info on page 326  
*Info técnica en pág 326*



0254 / 0255

**NOMA**

ALUMINIUM

Designer: 2J Design



**Finishes**  
**Acabados**

Anodized bright  
*Anodizado brillo*

Stainless steel look  
*Inox look*

Brushed black  
*Negro cepillado*

Antique bronze  
*Bronce antiguo*

Brushed brass cava  
*Latón cava cepillado*

←→	o — o
200 mm	128 mm
350 mm	256 mm

⊕  
Technical info on page 328  
*Info técnica en pág 328*



### Finishes Acabados

Polished chrome  
*Cromo brillo*

Anodized matt  
*Anodizado mate*

Stainless steel look  
*Inox look*

Brushed dark brass  
*Latón oscuro cepillado*

Matt White  
*Bianco mate*

Matt black  
*Negro mate*

Metallic grey  
*Gris metal*

Metallic brown  
*Marrón metal*

←→ | o — o

45 mm Consult technical info  
90 mm Consultar info técnica

100 mm

120 mm

150 mm

190 mm

200 mm

250 mm

300 mm

400 mm

500 mm

600 mm

900 mm

1480 mm



Technical info on page 323  
Info técnica en pág 323

0077

# ANGLE

ALUMINIUM

Designer: Viefe Studio





0495

# FLOID

ZAMAK

Designer: Frank Person

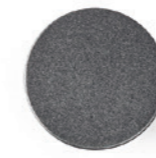

### Finishes Acabados

Brushed gold  
*Oro cepillado*

Pewter  
*Peltre*

Antique brass  
*Latón antiguo*

Matt black  
*Negro mate*

← →	o — o
Ø34,8 mm	-
143,6 mm	128 mm
207,6 mm	192 mm

⊕  
Technical info on page 308  
*Info técnica en pág 308*



0496

**BAU**

ZAMAK

Designer: Patricia Roig



**Finishes**  
**Acabados**

Brushed nickel  
*Níquel cepillado*

Brushed gold  
*Oro cepillado*

Matt black  
*Negro mate*

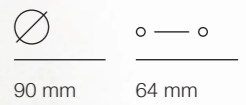

⊕  
Technical info on page 308  
*Info técnica en pág 308*

0127

JEY

ALUMINIUM

Designer: Viefe Studio



**Finishes**  
**Acabados**

Stainless steel look  
*Inox look*

Brushed brass cava  
*Latón cava cepillado*

Matt white  
*Blanco mate*

Matt black  
*Negro mate*

←→

147 mm  
197 mm  
247 mm  
297 mm  
347 mm  
397 mm  
447 mm  
497 mm  
597 mm  
697 mm  
797 mm  
897 mm  
997 mm  
1197 mm  
3000 mm\*

\* Available only in M1 and M2 finishes.  
Three metre profiles are delivered according to the units of the original packaging and cannot be sold separately.

*Disponibile solo en los acabados M1 y M2.  
Las barras de tres metros se sirven según las cantidades del embalaje original y no se pueden servir por separado.*

⊕  
Technical info on page 309  
*Info técnica en pág 309*



0127 JEY

0163 JEY2 (above)

ALUMINIUM

Designer: Viefe Studio

**Finishes**  
**Acabados**

Stainless steel look  
*Inox look*

Brushed brass cava  
*Latón cava cepillado*

Matt white  
*Blanco mate*

Matt black  
*Negro mate*

←→|

147 mm  
197 mm  
247 mm  
297 mm  
347 mm  
397 mm  
447 mm  
497 mm  
597 mm  
697 mm  
797 mm  
897 mm  
997 mm  
1197 mm  
3000 mm\*

\* Available only in M1 and M2 finishes. Three metre profiles are delivered according to the units of the original packaging and cannot be sold separately.

*Disponibile solo en los acabados M1 y M2. Las barras de tres metros se sirven según las cantidades del embalaje original y no se pueden servir por separado.*



Technical info on page 309  
*Info técnica en pág 309*



0168

COMO

ZAMAK

Designer: Viefe Studio



**Finishes**  
**Acabados**

Polished chrome  
*Cromo brillo*

Polished titanium black  
*Titanio negro brillo*

Polished copper  
*Cobre brillo*

Polished brass  
*Latón brillo*



26 mm  
41 mm



Technical info on page 310  
*Info técnica en pág 310*





0168

**COMO**

ZAMAK

Designer: Viefe Studio

**Finishes**  
**Acabados**

Matt chrome  
*Cromo mate*

Brushed nickel  
*Níquel cepillado*

Brushed copper  
*Cobre cepillado*

Brushed gold  
*Oro cepillado*

Matt black  
*Negro mate*

Matt white  
*Blanco mate*



26 mm  
41 mm



Technical info on page 310  
*Info técnica en pág 310*



0497

# DIABOLO

ALUMINIUM

Designer: Frank Person



### Finishes Acabados

Stainless steel look  
*Inox look*

Brushed brass  
*Latón cepillado*

Brushed black  
*Negro cepillado*

Brushed grey  
*Gris cepillado*



13,5 mm



Technical info on page 310  
*Info técnica en pág 310*



0499

**ROUND**

ALUMINIUM

Designer: Balutto Associati



**Finishes**  
**Acabados**

Stainless steel look  
*Inox look*

Brushed brass  
*Latón cepillado*

Brushed black  
*Negro cepillado*



25 mm



Technical info on page 310  
*Info técnica en pág 310*



0518

**WAY**

ALUMINIUM

Designer: Viefe Studio



**Finishes**  
**Acabados**

	←→	○ — ○ 1	○ — ○ 1/2	○ — ○ 2
Anodized matt <i>Anodizado mate</i>	50 mm	32 mm	-	-
	100 mm	64 mm	-	-
Stainless steel look <i>Inox look</i>	200 mm	128 mm	-	-
	400 mm	320 mm	-	-
Brushed dark brass <i>Latón oscuro cepillado</i>	800 mm	736 mm	368 mm	-
Matt White <i>Blanco mate</i>	1100 mm	1056 mm	-	352 mm
Matt black <i>Negro mate</i>				

⊕  
Technical info on page 311  
*Info técnica en pág 311*

0518

**WAY**

ALUMINIUM

Designer: Viefe Studio



**Finishes**  
**Acabados**

Anodized matt  
*Anodizado mate*

Stainless steel look  
*Inox look*

Brushed dark brass  
*Latón oscuro cepillado*

Matt White  
*Blanco mate*

Matt black  
*Negro mate*

←→	o — o 1	o — o 1/2	o — o 2
50 mm	32 mm	-	-
100 mm	64 mm	-	-
200 mm	128 mm	-	-
400 mm	320 mm	-	-
800 mm	736 mm	368 mm	-
1100 mm	1056 mm	-	352 mm

⊕  
Technical info on page 311  
*Info técnica en pág 311*



0511

# RAIL

ALUMINIUM

Designer: Teruel & Paré



### Finishes Acabados

Stainless steel look  
*Inox look*

Brushed black  
*Negro cepillado*

Brushed brass cava  
*Latón cava cepillado*

←→	o — o 1	o — o 2
180 mm	160 mm	-
280 mm	192 mm	-
600 mm	576 mm	192 mm
* 1150 mm	1120 mm	192 mm

\* Off-center / *Descentrado*

⊕  
Technical info on page 312  
*Info técnica en pág. 312*



0511

# RAIL

ALUMINIUM

Designer: Teruel & Paré



### Finishes

#### Acabados

Stainless steel look  
*Inox look*

Brushed black  
*Negro cepillado*

Brushed brass cava  
*Latón cava cepillado*

←→ |    o — o 1    o — o 2

180 mm	160 mm	-
280 mm	192 mm	-
600 mm	576 mm	192 mm
* 1150 mm	1120 mm	192 mm

\* Off-center / *Descentrado*



Technical info on page 312  
*Info técnica en pág 312*



0056

U

ZAMAK

Designer: Viefe Studio



**Finishes**  
**Acabados**

Matt white  
*Blanco mate*

←→	o — o
136,5 mm	128 mm
168,5 mm	160 mm
200,5 mm	192 mm
328,5 mm	320 mm
500,5 mm	492 mm

⊕  
Technical info on page 312  
*Info técnica en pág 312*





0056

U

ZAMAK

Designer: Viefte Studio

**Finishes**  
**Acabados**

	←→	o — o
Polished chrome <i>Cromo brillo</i>	136,5 mm	128 mm
Matt chrome <i>Cromo mate</i>	168,5 mm	160 mm
Brushed nickel <i>Niquel cepillado</i>	200,5 mm	192 mm
	328,5 mm	320 mm
	500,5 mm	492 mm
Matt black <i>Negro mate</i>		
Brushed copper <i>Cobre cepillado</i>		
Brushed brass <i>Latón cepillado</i>		
Matt white <i>Blanco mate</i>		
Brushed grey <i>Gris cepillado</i>		



⊕  
Technical info on page 312  
Info técnica en pág 312



0241

# ROMA

ZAMAK

Designer: 2J Design

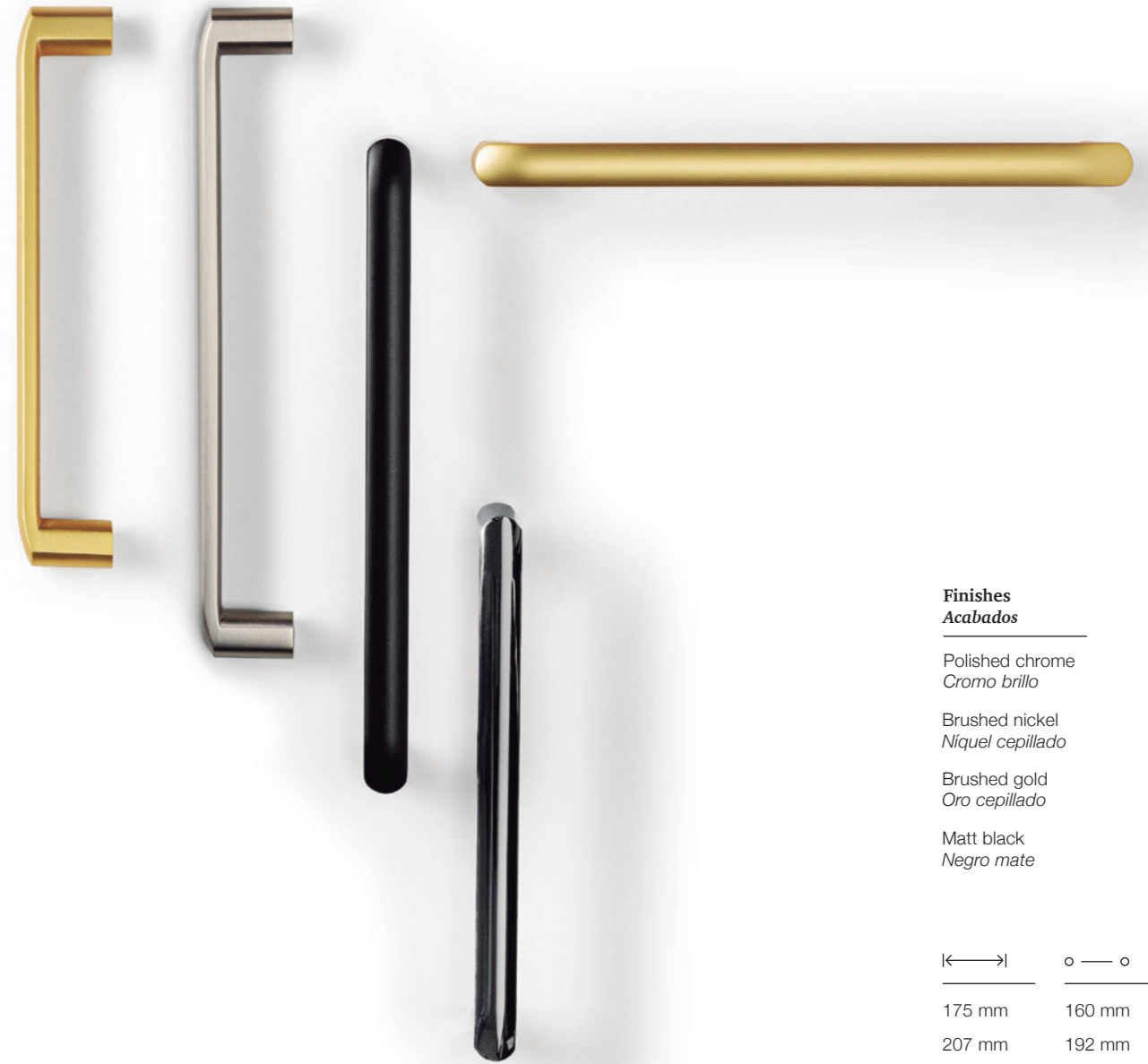

### Finishes Acabados

Polished chrome  
*Cromo brillo*

Brushed nickel  
*Níquel cepillado*

Brushed gold  
*Oro cepillado*

Matt black  
*Negro mate*

← →	o — o
175 mm	160 mm
207 mm	192 mm
335 mm	320 mm

⊕  
Technical info on page 313  
*Info técnica en pág 313*



0241

**ROMA**

ZAMAK

Designer: 2J Design



**Finishes**  
**Acabados**

Polished chrome  
*Cromo brillo*

Brushed nickel  
*Níquel cepillado*

Brushed gold  
*Oro cepillado*

Matt black  
*Negro mate*

←→ |    o — o

175 mm    160 mm

207 mm    192 mm

335 mm    320 mm



Technical info on page 313  
*Info técnica en pág 313*



0489

# BOL

ZAMAK / WOOD

Designer: Balutto Associati

## Finishes Acabados

Matt black + Sapelly  
*Negro mate + Sapelly*

Matt black + Beech  
*Negro mate + Haya*

Matt black + Matt white lacquered  
*Negro mate + Lacado blanco mate*



45 mm

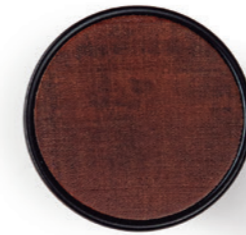



0507

# OBLONG

LEATHER / ZAMAK

Designer: Frank Person

## Finishes Acabados

Polished chrome + Beige / Brown / Black  
Cromo brillo + Beige / Marrón / Negro

Brushed gold + Beige / Brown / Black  
Oro cepillado + Beige / Marrón / Negro

Brushed grey + Beige / Brown / Black  
Gris cepillado + Beige / Marrón / Negro

Matt white + Beige  
Blanco mate + Beige

Matt black + Beige / Brown / Black  
Negro mate + Beige / Marrón / Negro

←→	o — o
70 mm	-
197 mm	160 mm



⊕  
Technical info on page 313  
Info técnica en pág 313



0494

**LAND**

ZAMAK

Designer: Héctor Diego



**Finishes**  
*Acabados*

Brushed gold  
*Oro cepillado*

Pewter  
*Peltre*

Antique brass  
*Latón antiguo*

Matt black  
*Negro mate*

|←→|      o — o

40 (Ø) mm      -

98 mm      64 mm

⊕  
Technical info on page 314  
*Info técnica en pág 314*



0494

**LAND**

ZAMAK

Designer: Héctor Diego



**Finishes  
Acabados**

Brushed gold  
*Oro cepillado*

Pewter  
*Peltre*

Antique brass  
*Latón antiguo*

Matt black  
*Negro mate*

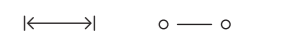

40 (Ø) mm

98 mm

-

64 mm



Technical info on page 314  
*Info técnica en pág 314*



0516

# PENDANT

ZAMAK

Designer: Frank Person



**Finishes**  
**Acabados**

Pewter  
*Peltre*

Antique brass  
*Latón antiguo*

Matt black  
*Negro mate*

←→	o — o
39,3 mm	-
138,4 mm	128 mm

⊕  
Technical info on page 316  
*Info técnica en pág 316*





0516

**PENDANT**

ZAMAK

Designer: Frank Person



**Finishes**  
**Acabados**

Pewter  
*Peltre*

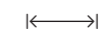

39,3 mm

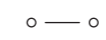

-

Antique brass  
*Latón antiguo*

138,4 mm

128 mm

Matt black  
*Negro mate*



Technical info on page 316  
*Info técnica en pág 316*



0486

**GRAF BIG**

ALUMINIUM

Designer: Viefe Studio

**Finishes  
Acabados**

	←→	o — o 1	o — o 2
Stainless steel look <i>Inox look</i>	(Ø) 38 mm	-	-
	(Ø) 50 mm	-	-
Brushed brass <i>Latón cepillado</i>	224 mm	192 mm	-
	352 mm	320 mm	-
Brushed black <i>Negro cepillado</i>	1200 mm	1168 mm	584 mm



Technical info on page 317  
Info técnica en pág 317



0486

# GRAF BIG

ALUMINIUM

Designer: Viefe Studio



**Finishes**  
**Acabados**

Stainless steel look  
*Inox look*

Brushed brass  
*Latón cepillado*

Brushed black  
*Negro cepillado*



↳←	o — o 1	o — o 2
(Ø) 38 mm	-	-
(Ø) 50 mm	-	-
224 mm	192 mm	-
352 mm	320 mm	-
1200 mm	1168 mm	584 mm

⊕  
Technical info on page 317  
*Info técnica en pág 317*

0486

# GRAF BIG

ALUMINIUM

Designer: Viefe Studio



**Finishes**  
**Acabados**

Stainless steel look  
*Inox look*

Brushed brass  
*Latón cepillado*

Brushed black  
*Negro cepillado*

←→	o — o 1	o — o 2
(Ø) 38 mm	-	-
(Ø) 50 mm	-	-
224 mm	192 mm	-
352 mm	320 mm	-
1200 mm	1168 mm	584 mm

⊕  
Technical info on page 317  
Info técnica en pág 317



0430

# GRAF MINI

ALUMINIUM

Designer: Viefe Studio

**Finishes**

*Acabados*

Stainless steel look  
*Inox look*

Brushed brass  
*Latón cepillado*

Brushed black  
*Negro cepillado*

←→

o — o 1

o — o 2

10 mm

-

-

60 mm

-

-

Includes non-twisting tip / Incluye punta anti-giro

182 mm

160 mm

-

278 mm

256 mm

-

1200 mm

1178 mm

589 mm



Technical info on page 317  
Info técnica en pág 317

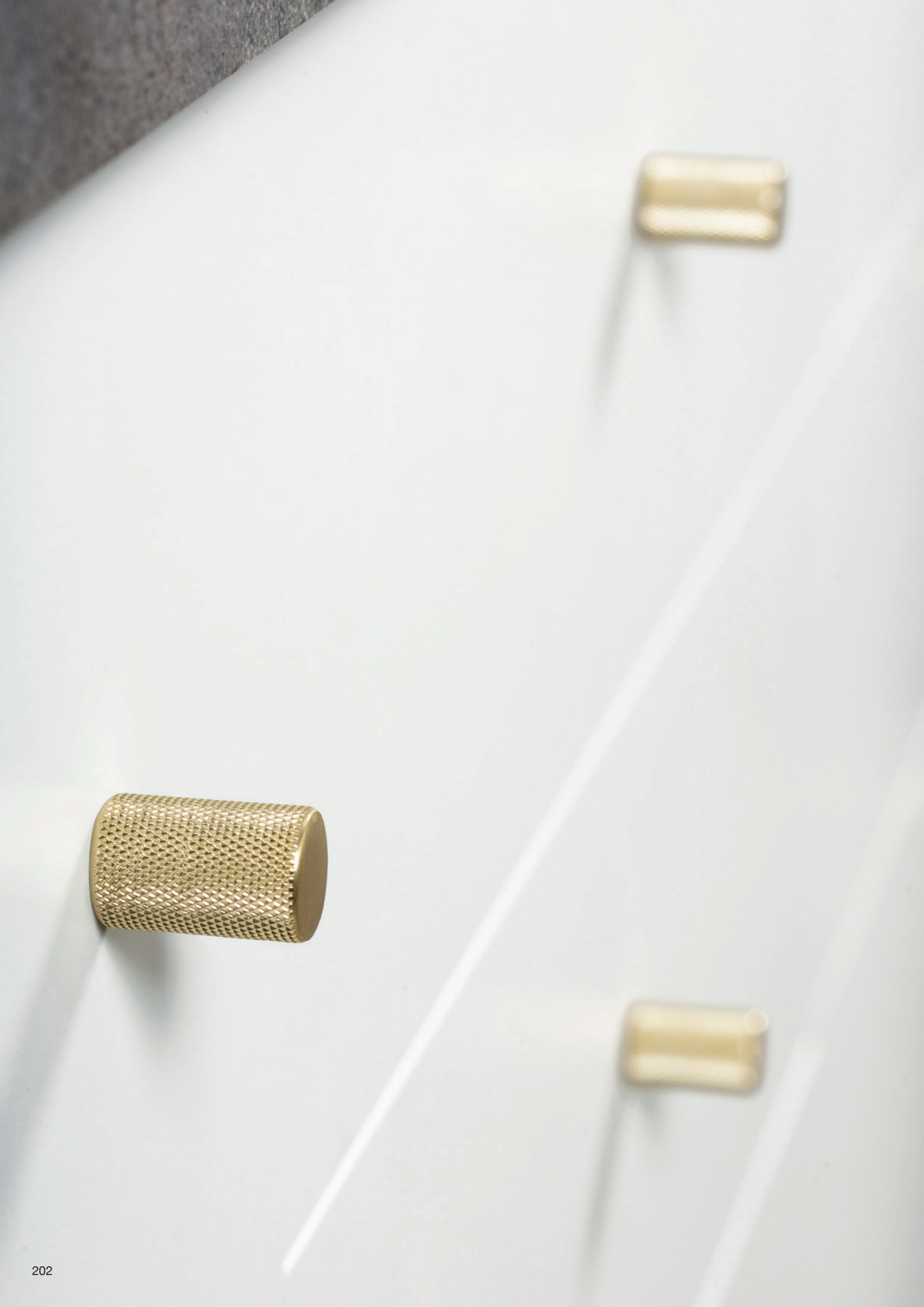

0109

**GRAF**

ALUMINIUM

Designer: Viefe Studio

**Finishes**  
**Acabados**

Polished chrome  
*Cromo brillo*

Anodized matt  
*Anodizado mate*

Stainless steel look  
*Inox look*

Brushed brass  
*Latón cepillado*

Matt black  
*Negro mate*



17,5 mm



Technical info on page 318  
*Info técnica en pág 318*



0459

**LINES**

ZAMAK

Designer: Teruel & Paré

**Finishes**  
**Acabados**

- Brushed níquel  
*Níquel cepillado*
- Brushed gold  
*Oro cepillado*
- Brushed mole grey  
*Gris topo cepillado*
- Matt black  
*Negro mate*

← →	o — o
170 mm	160 mm
330 mm	320 mm



⊕  
Technical info on page 315  
*Info técnica en pág 315*

0446

ESTE

ZAMAK

Designer: Balutto Associati



**Finishes**  
**Acabados**

Polished chrome  
*Cromo brillo*

Matt chrome  
*Cromo mate*

Brushed nickel  
*Níquel cepillado*

Brushed copper  
*Cobre cepillado*

Brushed gold  
*Oro cepillado*

Graphite grey  
*Gris grafito*

Matt black  
*Negro mate*

←→ |    o — o  
172 mm    160 mm



Technical info on page 314  
*Info técnica en pág 314*





0447

**BELLA**

ZAMAK

Designer: Balutto Associati

**Finishes**  
**Acabados**

Brushed copper  
*Cobre cepillado*

Brushed gold  
*Oro cepillado*

Graphite grey  
*Gris grafito*

Matt black  
*Negro mate*

←→ |    ○ — ○  
176 mm    160 mm

⊕  
Technical info on page 318  
*Info técnica en pág 318*





0449

# HEXXA

ALUMINIUM + ZAMAK

Designer: Alexis Vivet

**Finishes**  
**Acabados**

	←→	
Matt white <i>Blanco mate</i>	200 mm	
	350 mm	
Matt black <i>Negro mate</i>	1100 mm	
	3000 mm *	
Metallic grey <i>Gris metal</i>		
Metallic brown <i>Marrón metal</i>		

\* Three metre profiles are delivered according to the units of the original packaging and cannot be sold separately.  
*Las barras de tres metros se sirven según las cantidades del embalaje original y no se pueden servir por separado.*



Technical info on page 319  
*Info técnica en pág 319*

0449

# HEXXA

ALUMINIUM + ZAMAK

Designer: Alexis Vivet

## Finishes Acabados

Matt white  
*Blanco mate*

Matt black  
*Negro mate*

Metallic grey  
*Gris metal*

Metallic brown  
*Marrón metal*

|←→|

200 mm

350 mm

1100 mm

3000 mm \*

\* Three metre profiles are delivered according to the units of the original packaging and cannot be sold separately.

*Las barras de tres metros se sirven según las cantidades del embalaje original y no se pueden servir por separado.*



Technical info on page 319  
*Info técnica en pág 319*





0094

**HIDE**

ZAMAK

Designer: Viefe Studio



**Finishes**  
**Acabados**

	←→	o — o
Polished chrome <i>Cromo brillo</i>	90 mm	64 mm
Brushed nickel <i>Níquel cepillado</i>	180 mm	128 mm
Brushed gold <i>Oro cepillado</i>	200 mm	128 mm
Matt white <i>Blanco mate</i>		
Matt black <i>Negro mate</i>		
Chrome look <i>Cromo look</i>		

⊕  
Technical info on page 316  
Info técnica en pág 316



0119

**WAVE**

ZAMAK

Designer: Viefe Studio



**Finishes**  
**Acabados**

Polished chrome  
*Cromo brillo*

Brushed nickel  
*Níquel cepillado*

Matt black  
*Negro mate*

←→

45 mm  
173 mm

o — o

32 mm  
160 mm



Technical info on page 319  
*Info técnica en pág 319*



0105

(combinable with 0094)

**NEST**

ZAMAK

Designer: Viefé Studio



**Finishes**  
**Acabados**

Polished chrome  
*Cromo brillo*

Brushed nickel  
*Níquel cepillado*

Polished chrome + White  
*Cromo brillo + Blanco*

Brushed nickel + White  
*Níquel cepillado + Blanco*

*Matt black*  
*Negro mate*



⊕  
Technical info on page 320  
*Info técnica en pág 320*



0235

**CLOS**

ZAMAK

Designer: Viefe Studio



**Finishes**

**Acabados**

Matt white  
*Blanco mate*

Matt black  
*Negro mate*

Polished chrome  
*Cromo brillo*

Brushed nickel  
*Níquel cepillado*



160 mm



128 mm



Technical info on page 320  
*Info técnica en pág 320*

0366

**CUBIC**

ZAMAK

Designer: Viefe Studio

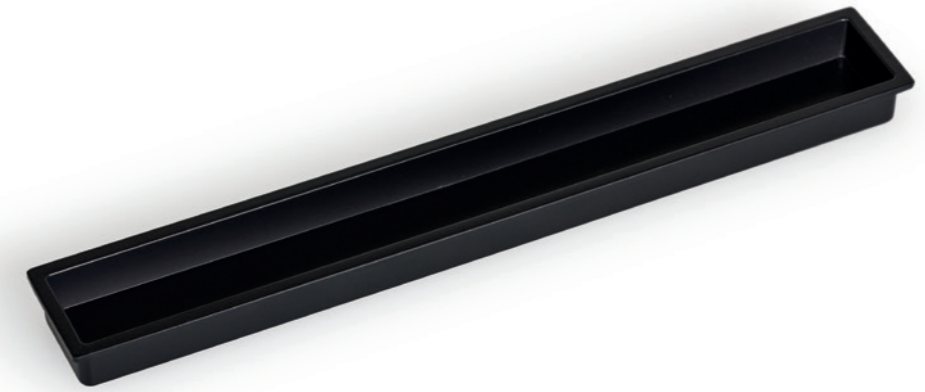

**Finishes**  
**Acabados**

Matt white  
*Blanco mate*

Matt black  
*Negro mate*

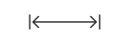

160 mm



Technical info on page 320  
*Info técnica en pág 320*



0073

**TAP**

ZAMAK

Designer: Viefe Studio

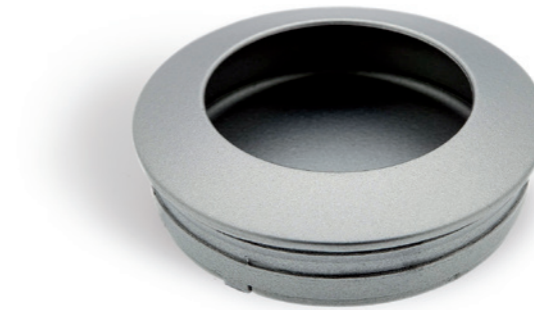

**Finishes**  
**Acabados**

Chrome look  
*Cromo look*

Matt black  
*Negro mate*

∅ 1

35,5 mm

55,3 mm

∅ 2

40 mm

60 mm



Technical info on page 321  
*Info técnica en pág 321*



0301

# SENSE MINI

ALUMINIUM

Designer: Viefte Studio



**Finishes**  
**Acabados**

Polished chrome  
*Cromo brillo*

Matt black  
*Negro mate*

Stainless steel look  
*Inox look*

Brushed dark brass  
*Latón oscuro cepillado*

←→	o — o
103 mm	96 mm
167 mm	160 mm
263 mm	256 mm

⊕  
Technical info on page 321  
*Info técnica en pág 321*



0195

**SENSE**

ALUMINIUM

Designer: Viefe Studio



**Finishes**  
**Acabados**

Polished chrome  
*Cromo brillo*

Stainless steel look  
*Inox look*

Brushed black  
*Negro cepillado*

←→	○ — ○
135 mm	128 mm
199 mm	192 mm
327 mm	320 mm
487 mm	480 mm

⊕  
Technical info on page 321  
*Info técnica en pág 321*



0451

**FELTRE**

ZAMAK

Designer: Balutto Associati

**Finishes**  
**Acabados**

Brushed nickel  
*Níquel cepillado*

Graphite grey  
*Gris grafito*

Matt black  
*Negro mate*

←→ |    o — o  
218 mm    192 mm



Technical info on page 318  
*Info técnica en pág 318*



0452

**BRAVE**

ALUMINIUM

Designer: Viefe Studio



**Finishes**  
**Acabados**

Matt white  
*Blanco mate*

Matt black  
*Negro mate*

Metallic grey  
*Gris metal*

Metallic brown  
*Marrón metal*

↳—→	○ — ○ 1	○ — ○ 2
160 mm	128 mm	-
240 mm	192 mm	-
400 mm	320 mm	-
600 mm	192 mm	480 mm
1040 mm	192 mm	992 mm
1150 mm	192 mm	1120 mm



Technical info on page 324  
Info técnica en pág 324

0444

PEAK

ALUMINIUM

Designer: Viefe Studio



**Finishes**  
**Acabados**

Stainless steel look  
*Inox look*

Brushed black  
*Negro cepillado*

Matt white  
*Blanco mate*

Metallic grey  
*Gris metal*

Metallic brown  
*Marrón metal*

←→	o — o 1	o — o 2
120 mm	64 mm	-
250 mm	192 mm	160 mm
500 mm	448 mm	160 mm
800 mm	768 mm	160 mm
1150 mm	1120 mm	160 mm
1800 mm	1760 mm	160 mm

⊕  
Technical info on page 325  
info técnica en pág 325



0375

**VANN**

ALUMINIUM

Designer: Alexis Vivet



**Finishes**  
**Acabados**

Anodized bright  
*Anodizado brillo*

Anodized matt  
*Anodizado mate*

Matt black  
*Negro mate*

Stainless steel look  
*Inox look*

Brushed dark brass  
*Latón oscuro cepillado*

	◀—▶	○ — ○ 1	○ — ○ 2
	100 mm	64 mm	-
	200 mm	128 mm	-
	350 mm	256 mm	-
	1200 mm	1120 mm	384mm

⊕  
Technical info on page 325  
*Info técnica en pág 325*



#### Finishes

##### Acabados

Anodized bright  
*Anodizado brillo*

Anodized matt  
*Anodizado mate*

Matt black  
*Negro mate*

Stainless steel look  
*Inox look*

Brushed dark brass  
*Latón oscuro cepillado*

←→	○ — ○ 1	○ — ○ 2
100 mm	64 mm	-
200 mm	128 mm	-
350 mm	256 mm	-
1200 mm	1120 mm	384mm



Technical info on page 325  
*Info técnica en pág 325*



0117

# CURVE

ALUMINIUM

Designer: Viefe Studio

## Finishes Acabados

Anodized matt  
*Anodizado mate*

Stainless steel look  
*Inox look*

Brushed grey  
*Gris cepillado*

Matt white  
*Blanco mate*

Matt black  
*Negro mate*

←→

45 mm

100 mm

200 mm

300 mm

400 mm

500 mm

o — o

32 mm

64 mm

128 mm

192 mm

320 mm

416 mm



Technical info on page 327  
*Info técnica en pág. 327*

0139 / 0140

**LINEAR**

ALUMINIUM

Designer: Viefe Studio



**Finishes**  
**Acabados**

Stainless steel look  
*Inox look*

Brushed black  
*Negro cepillado*

←→

147 mm

197 mm

247 mm

297 mm

347 mm

397 mm

447 mm

497 mm

597 mm

697 mm

797 mm

897 mm

997 mm

1197 mm



Technical info on page 327  
*Info técnica en pág 327*

0434

# VECTOR

ALUMINIUM

Designer: Viefe Studio



## Finishes Acabados

Stainless steel look  
*Inox look*

Brushed black  
*Negro cepillado*

Brushed grey  
*Gris cepillado*

←→

147 mm

197 mm

247 mm

297 mm

347 mm

397 mm

447 mm

497 mm

597 mm

697 mm

797 mm

897 mm

997 mm

1197 mm



Technical info on page 328  
*Info técnica en pág 328*



0343

## GRADA

ALUMINIUM

Designer: Viefe Studio

### Finishes Acabados

|←→|

Anodized matt <i>Anodizado mate</i>	147 mm
	197 mm
Stainless steel look <i>Inox look</i>	247 mm
	297 mm
Matt white <i>Blanco mate</i>	347 mm
	397 mm
Matt black <i>Negro mate</i>	447 mm
	497 mm
Anodized bright <i>Anodizado brillo</i>	597 mm
	697 mm
	797 mm
	897 mm
	997 mm
	1197 mm
	3000 mm *

\*  
Three metre profiles are delivered according to the units of the original packaging and cannot be sold separately.

*Las barras de tres metros se sirven según las cantidades del embalaje original y no se pueden servir por separado.*



Technical info on page 330  
*Info técnica en pág 330*

0380

# STEEP

ALUMINIUM

Designer: Viefe Studio

**Finishes**  
**Acabados**

---

Anodized bright  
*Anodizado brillo*

Stainless steel look  
*Inox look*

Matt black  
*Negro mate*

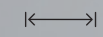

3000 mm

Three metre profiles are delivered according to the units of the original packaging and cannot be sold separately.

*Las barras de tres metros se sirven según las cantidades del embalaje original y no se pueden servir por separado.*



Technical info on page 330  
*Info técnica en pág 330*

0250 / 0251

# FORMA

ALUMINIUM

Designer: 2J Design



147 mm

197 mm

247 mm

297 mm

347 mm

397 mm

**Finishes**  
**Acabados**

---

Stainless steel look  
*Inox look*

447 mm

497 mm

597 mm

697 mm

797 mm

897 mm

997 mm

1197 mm



Technical info on page 329  
*Info técnica en pág 329*

0334

# BRIKK

ALUMINIUM

Designer: Alexis Vivet

### Finishes Acabados

	←→	○ — ○ 1	○ — ○ 2	○ — ○ 3
140 mm		32 mm	-	-
190 mm		64 mm	-	-
240 mm		96 mm	-	-
290 mm		160 mm	-	-
340 mm		192 mm	-	-
390 mm		128 mm	260 mm	-
440 mm		160 mm	310 mm	-
490 mm		192 mm	360 mm	-
590 mm		224 mm	460 mm	-
690 mm		256 mm	560 mm	-
790 mm		320 mm	660 mm	-
890 mm		384 mm	760 mm	-
990 mm		320 mm	640 mm	860 mm
1190 mm		320 mm	832 mm	1060 mm



Technical info on page 329  
 Info técnica en pág 329





0053

**DINO**

ZAMAK

Designer: Viefe Studio



**Finishes**  
*Acabados*

Polished chrome  
*Cromo brillo*

Brushed nickel  
*Niquel cepillado*

Matt white  
*Blanco mate*

Matt black  
*Negro mate*

Aluminium look  
*Aluminio look*

↳←	o — o 1	o — o 2
156 mm	96 mm	128 mm
221 mm	160 mm	192 mm
349 mm	288 mm	320 mm

⊕  
Technical info on page 326  
*Info técnica en pág 326*



0373

**NICK**

ZAMAK

Designer: Alexis Vivet



**Finishes**  
**Acabados**

Polished chrome  
*Cromo brillo*

Brushed nickel  
*Níquel cepillado*

Brushed copper  
*Cobre cepillado*

Brushed brass  
*Latón cepillado*

←→	o — o
50 mm	32 mm
178 mm	160 mm

⊕  
Technical info on page 322  
*Info técnica en pág 322*



0322

**CUTT**

ALUMINIUM

Designer: Alexis Vivet

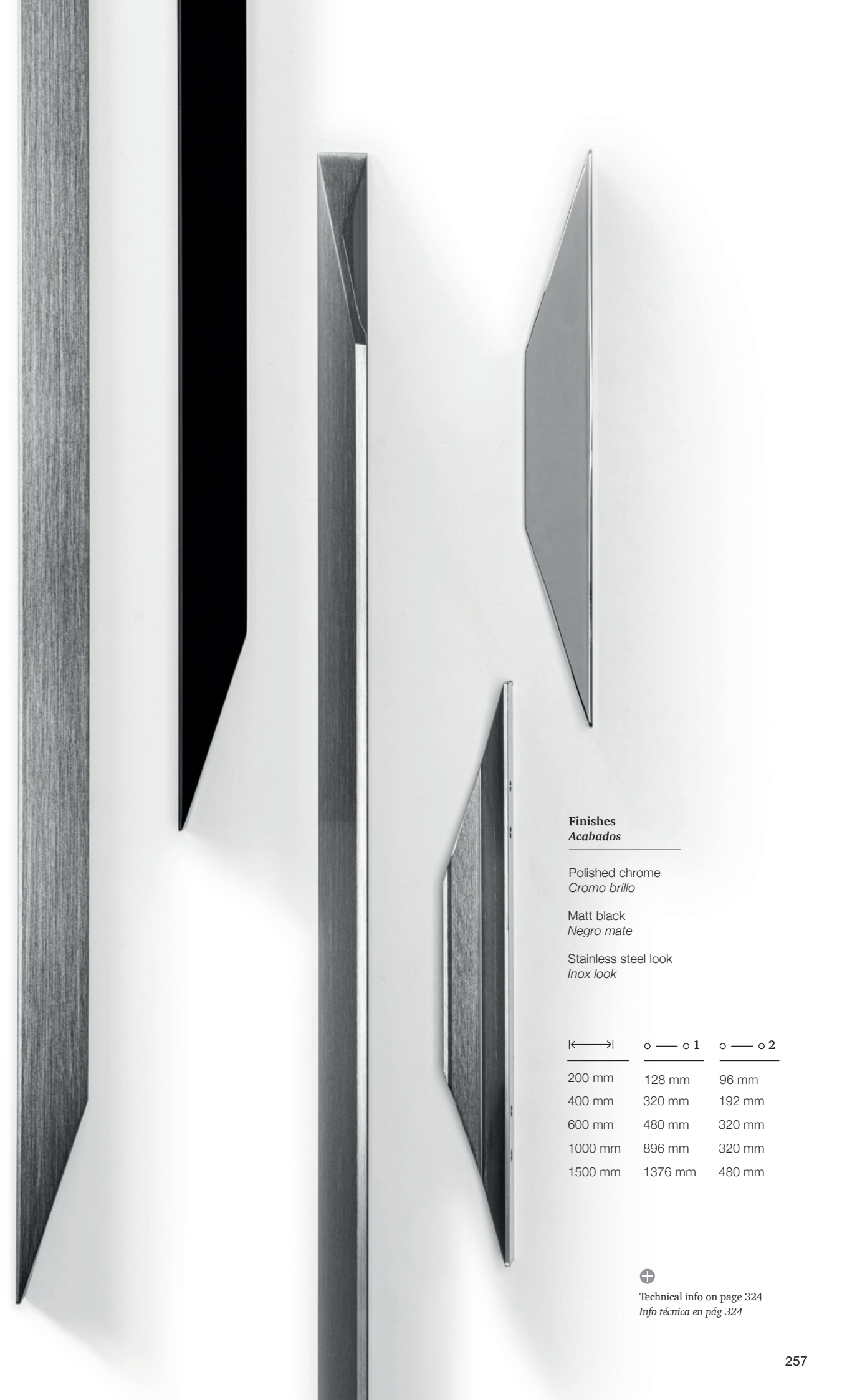

**Finishes**  
**Acabados**

Polished chrome  
*Cromo brillo*

Matt black  
*Negro mate*

Stainless steel look  
*Inox look*

↳→	○ — ○ 1	○ — ○ 2
200 mm	128 mm	96 mm
400 mm	320 mm	192 mm
600 mm	480 mm	320 mm
1000 mm	896 mm	320 mm
1500 mm	1376 mm	480 mm



Technical info on page 324  
*Info técnica en pág 324*



0410

# BUTTON

ZAMAK

Designer: Alexis Vivet



**Finishes**  
**Acabados**

Pewter  
Peltre

Antique Brass  
Latón antiguo

Matt black  
Negro mate



175 mm



160 mm



Technical info on page 331  
Info técnica en pág 331



0393

**DUKE**

ZAMAK

Designer: Viefte Studio



**Finishes**  
**Acabados**

Antique copper  
*Cobre antiguo*

Antique silver  
*Plata antigua*

Matt black  
*Negro mate*

Matt white  
*Blanco mate*

Pewter  
*Peltre*

Antique Brass  
*Latón antiguo*

Polished chrome  
*Cromo brillo*

Brushed nickel  
*Níquel cepillado*

Brushed brass  
*Latón cepillado*

Brushed copper  
*Cobre cepillado*



31,4 mm



Technical info on page 331  
*Info técnica en pág 331*

0226

REDO

ZAMAK

Designer: 2J Design



**Finishes**  
**Acabados**

Antique Brass  
*Latón antiguo*

Brushed nickel  
*Níquel cepillado*

Brushed copper  
*Cobre cepillado*

Pewter  
*Peltre*

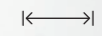

137 mm

201 mm

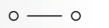

128 mm

192 mm



Technical info on page 332  
*Info técnica en pag 332*



0405

# RAVIOLO

ZAMAK

Designer: Balutto Associati



**Finishes**  
**Acabados**

Pewter  
*Peltre*

Antique Brass  
*Latón antiguo*

← →

Ø 29 mm

172 mm

○ — ○

-

96 mm



Technical info on page 332  
*Info técnica en pág 332*

0394

AVA

ZAMAK



Designer: Viefe Studio



**Finishes**  
**Acabados**

Pewter  
*Peltre*

Antique Brass  
*Latón antiguo*

  
 128,5 mm    96 mm

 Technical info on page 332  
*Info técnica en pág 332*

0390

PETRA

ZAMAK

Designer: Viefe Studio





**Finishes**  
**Acabados**

Antique copper  
*Cobre antiguo*

Antique silver  
*Plata antigua*

Matt black  
*Negro mate*

  
 97 mm    64 mm

 Technical info on page 333  
*Info técnica en pág 333*

0392

# ORION

ZAMAK

Designer: Viefe Studio



**Finishes**  
**Acabados**

Antique copper  
*Cobre antiguo*

Antique silver  
*Plata antigua*



136 mm



128 mm



Technical info on page 333  
*Info técnica en pág 333*



0391

# AURA

ZAMAK

Designer: Viefe Studio



**Finishes**  
**Acabados**

Antique copper  
*Cobre antiguo*

Antique silver  
*Plata antigua*



87 mm



64 mm



Technical info on page 333  
*Info técnica en pág 333*





**Finishes**  
**Acabados**

Polished chrome + Beige / Brown / Black  
*Cromo brillo + Beige / Marrón / Negro*

Pewter + Beige / Brown / Black  
*Peltre + Beige / Marrón / Negro*

Matt black + Beige / Brown / Black  
*Negro mate + Beige / Marrón / Negro*

Brushed brass + Beige / Brown / Black  
*Latón cepillado + Beige / Marrón / Negro*

←→	○ — ○
70 mm	-
150 mm	128 mm
182 mm	160 mm

⊕  
Technical info on page 334  
*Info técnica en pág 334*



0239

# ARA W

ALUMINIUM + WOOD

Designer: 2J Design



**Finishes**  
**Acabados**

Stainless steel look + Oak  
*Inox look + Roble*

Stainless steel look + Walnut  
*Inox look + Nogal*

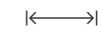

220 mm  
284 mm

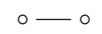

160 mm  
224 mm



Technical info on page 334  
*Info técnica en pág 334*



0340

**BARCCO**

WOOD

Designer: Alexis Vivet



**Finishes**  
**Acabados**

Ash  
*Fresno*

Walnut  
*Nogal*

Beech raw  
*Haya crudo*

K →	o — o 1	o — o 2
200 mm	160 mm	-
400 mm	320 mm	-
600 mm	320 mm	480 mm

⊕  
Technical info on page 335  
*Info técnica en pág 335*

0165

# CALIN

WOOD

Designer: Viefe Studio



### Finishes Acabados

Raw brushed  
*Crudo cepillado*

White brushed  
*Blanco cepillado*

Brown brushed  
*Marrón cepillado*

Black brushed  
*Negro cepillado*

240 mm    160 mm

Technical info on page 335  
*Info técnica en pág. 335*



0166

# ECHO

WOOD

Designer: Viefe Studio



### Finishes Acabados

Raw brushed  
*Crudo cepillado*

White brushed  
*Blanco cepillado*

Brown brushed  
*Marrón cepillado*

Black brushed  
*Negro cepillado*



60 mm



Technical info on page 335  
*Info técnica en pág. 335*

0374

# BALL

ZAMAK

Designer: Alexis Vivet



### Finishes Acabados

Polished chrome  
*Cobre brillo*

Brushed nickel  
*Níquel cepillado*

Brushed brass  
*Latón cepillado*



23,3 mm

29,5 mm



Technical info on page 336  
*Info técnica en pág. 336*

0243 ST

# LOW ST

ZAMAK

Designer: Viefe Studio

### Finishes Acabados

Brushed nickel  
*Níquel cepillado*

←→	○ — ○
78 mm	64 mm
206 mm	192 mm



⊕  
Technical info on page 336  
*Info técnica en pág 336*

0281

# FLAT

ZAMAK

Designer: Oriol Barri

### Finishes Acabados

Brushed nickel  
*Níquel cepillado*

←→	○ — ○
174,8 mm	160 mm



⊕  
Technical info on page 336  
*Info técnica en pág 336*

0369

# RITTA

ALUMINIUM

Designer: Teruel & Paré

### Finishes Acabados

Polished chrome  
*Cromo brillo*

Matt black  
*Negro mate*

Stainless steel look  
*Inox look*



←→	○ — ○
130 mm	64 mm
260 mm	128 mm

⊕  
Technical info on page 337  
*Info técnica en pág 337*

0219

# ARROW

ZAMAK

Designer: 2J Design

### Finishes Acabados

Brushed nickel  
*Níquel cepillado*



←→	○ — ○
223 mm	
	192 mm

⊕  
Technical info on page 331  
*Info técnica en pág 331*

0376

**BOXX**

ZAMAK

Designer: Alexis Vivet



0091

**RASO**

ZAMAK

Designer: Viefte Studio

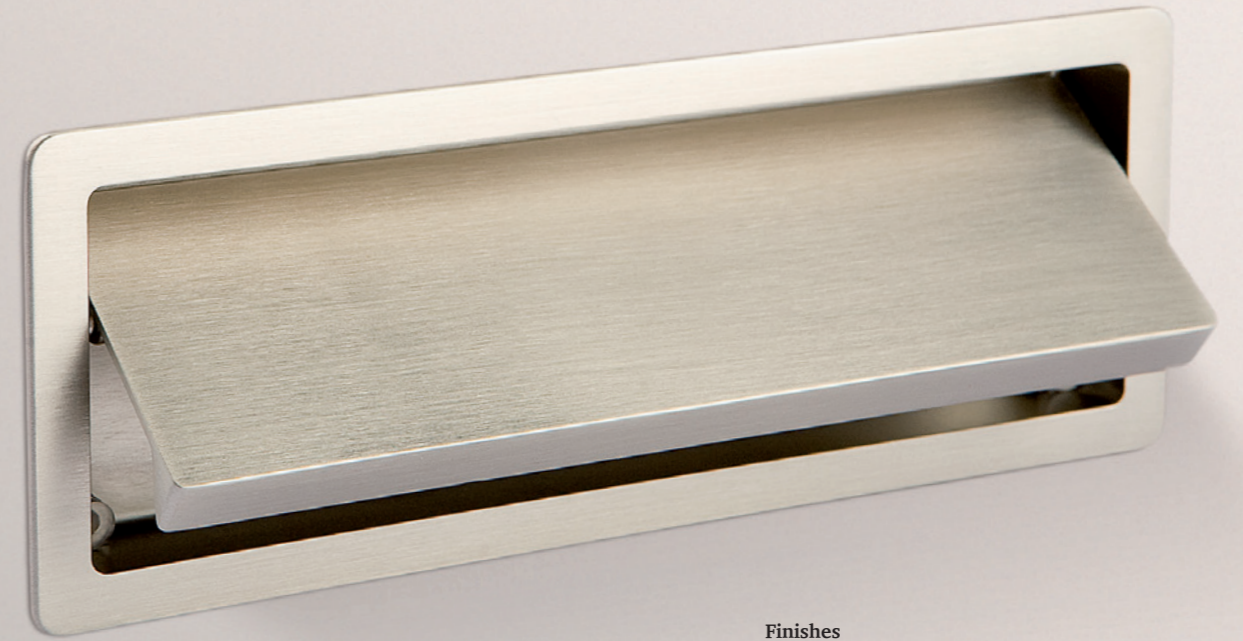

**Finishes**  
**Acabados**

	◀—▶	○ — ○
Brushed nickel	70 mm	32 mm
Níquel cepillado	152,5 mm	108 mm



Technical info on page 337  
Info técnica en pág 337



**Finishes**  
**Acabados**

	◀—▶
Polished chrome	15 mm
Cromo brillo	
Matt chrome	+
Cromo mate	
Brushed nickel	+
Níquel cepillado	
Matt black	+
Negro mate	



Technical info on page 337  
Info técnica en pág 337

0312

**ARKO**

ALUMINIUM

Designer: Viefte Studio



**Finishes**  
**Acabados**

Stainless steel look  
Inox look

	◀—▶	○ — ○
	186 mm	160 mm
	218 mm	192 mm
	292 mm	256 mm



Technical info on page 338  
Info técnica en pág 338

0206

**ARCH**

ZAMAK

Designer: 2J Design

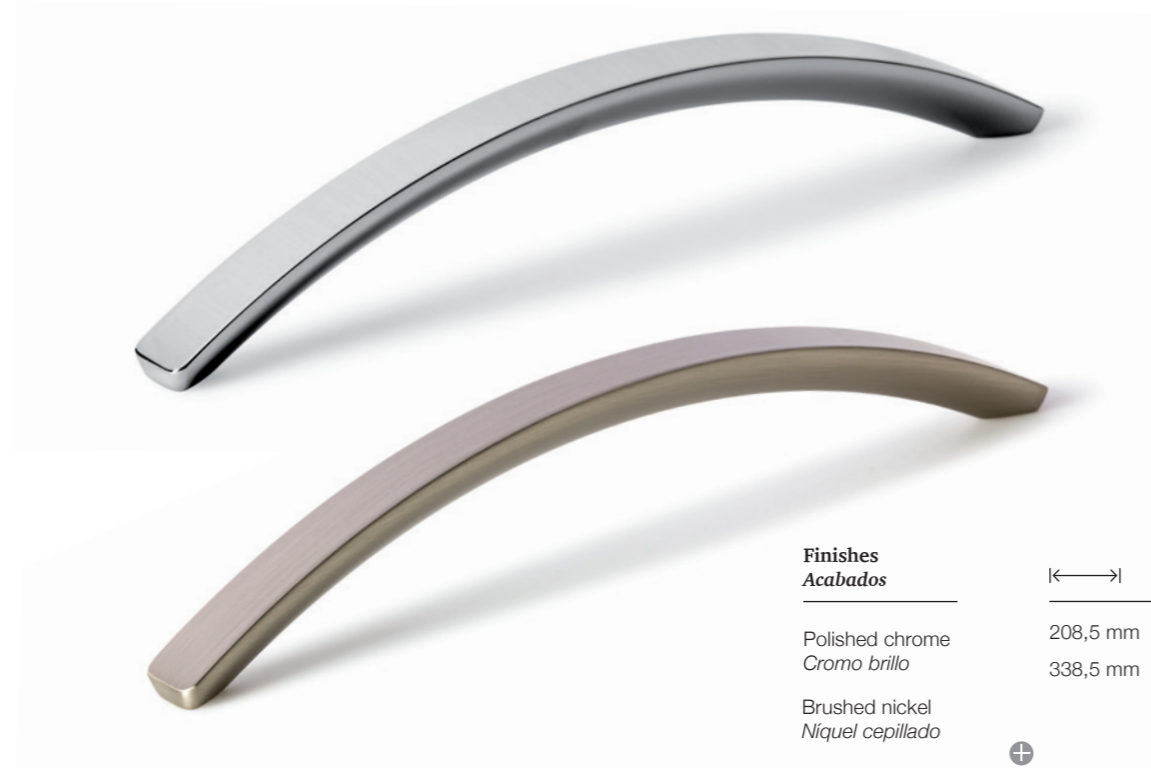

**Finishes  
Acabados**

Polished chrome  
*Cromo brillo*

Brushed nickel  
*Níquel cepillado*

	←→	o — o
Polished chrome <i>Cromo brillo</i>	208,5 mm	192 mm
Brushed nickel <i>Níquel cepillado</i>	338,5 mm	320 mm

⊕  
Technical info on page 323  
*Info técnica en pág 323*

0064

**KOMBI**

STAINLESS STEEL

Designer: Viefé Studio



**Finishes  
Acabados**

Brushed stainless steel  
*Inox cepillado*

	←→	o — o
Brushed stainless steel <i>Inox cepillado</i>	182 mm	160 mm
	214 mm	192 mm
	314 mm	292 mm
	364 mm	342 mm
	414 mm	392 mm
	514 mm	492 mm
	814 mm	792 mm
	1114 mm	1092 mm

⊕  
Technical info on page 338  
*Info técnica en pág 338*

0162

**KADO**

ZAMAK

Designer: Viefé Studio

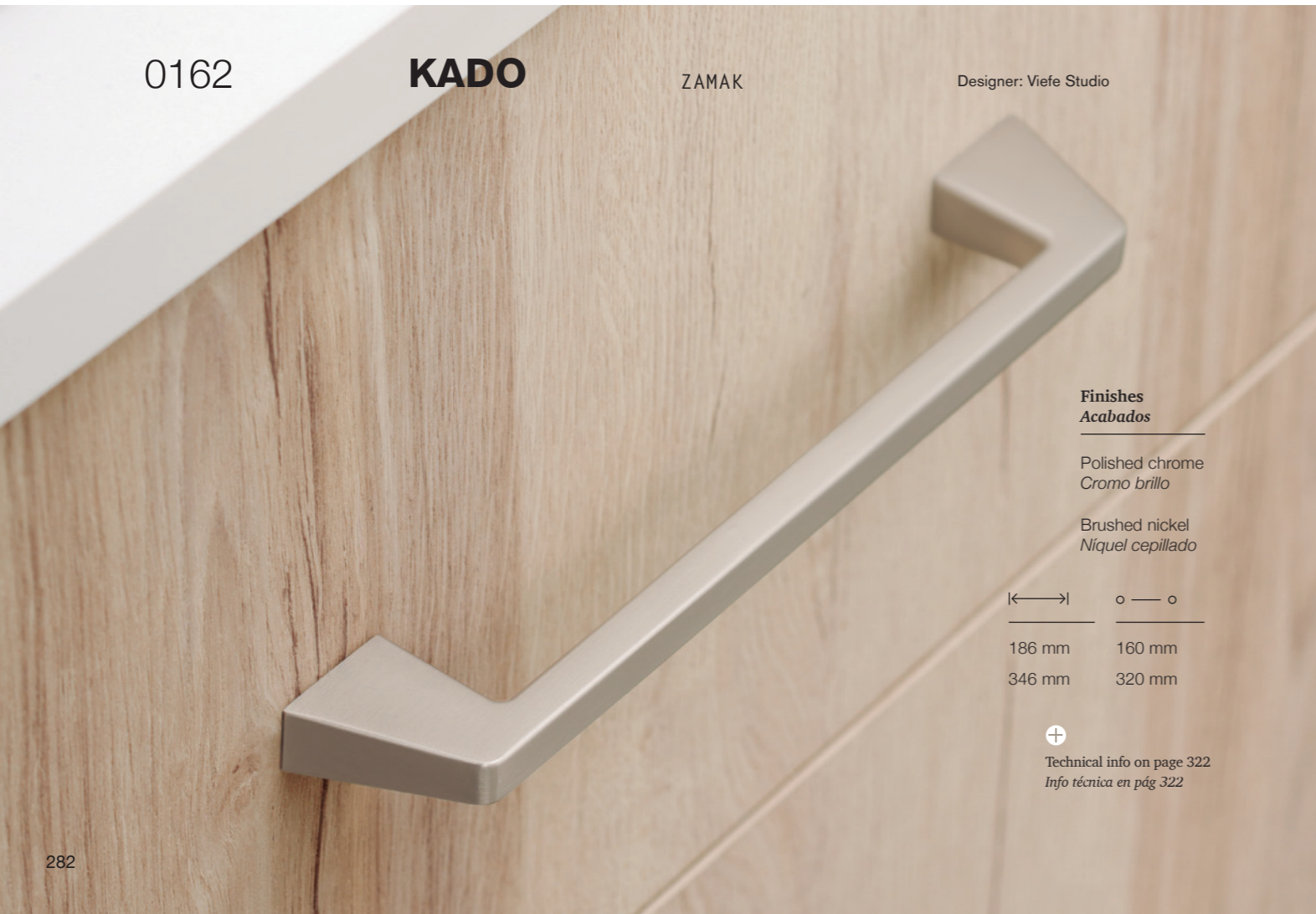

**Finishes  
Acabados**

Polished chrome  
*Cromo brillo*

Brushed nickel  
*Níquel cepillado*

	←→	o — o
Polished chrome <i>Cromo brillo</i>	186 mm	160 mm
Brushed nickel <i>Níquel cepillado</i>	346 mm	320 mm

⊕  
Technical info on page 322  
*Info técnica en pág 322*

0035

**ACER**

STAINLESS STEEL

Designer: 2J Design

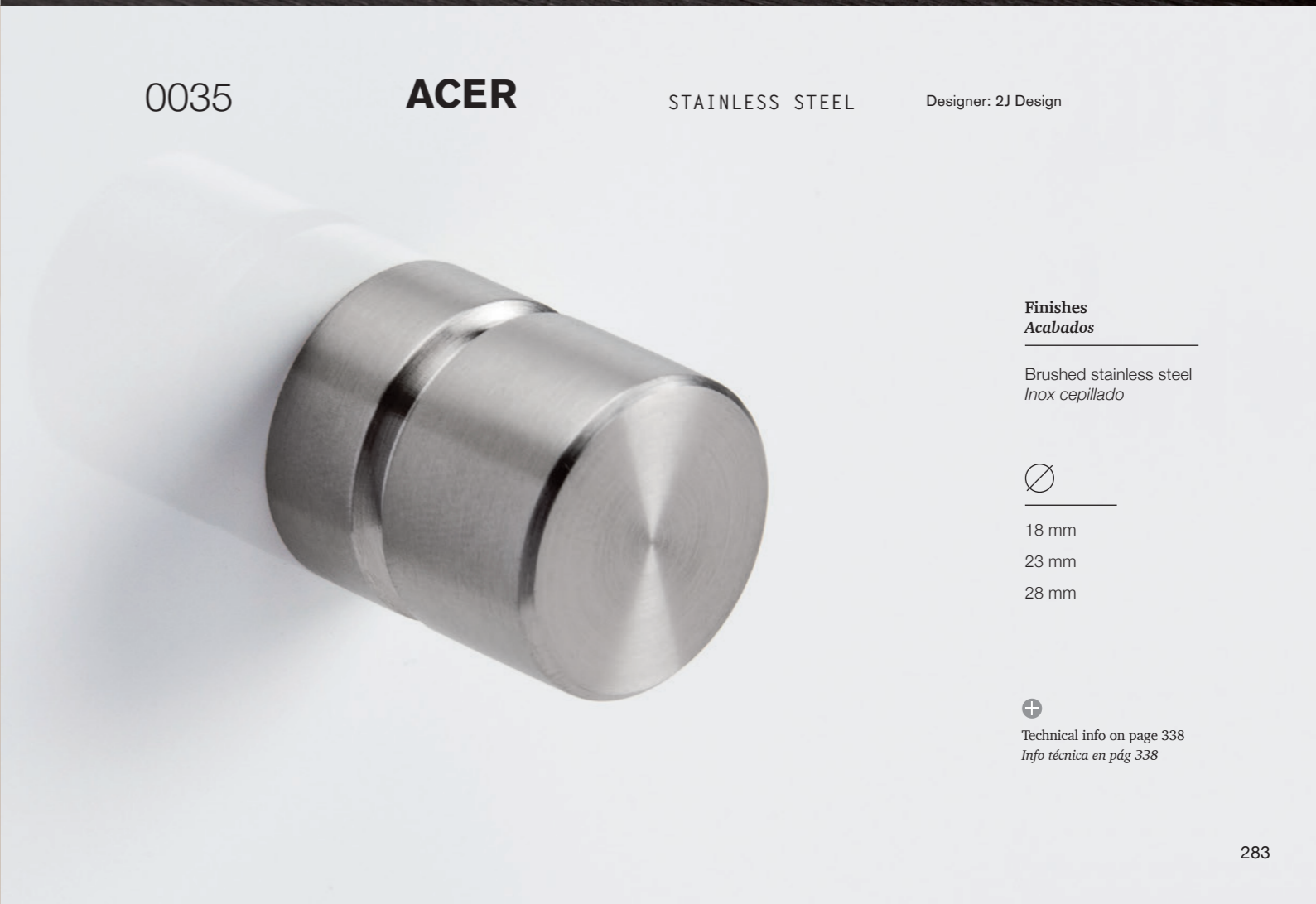

**Finishes  
Acabados**

Brushed stainless steel  
*Inox cepillado*

∅
18 mm
23 mm
28 mm

⊕  
Technical info on page 338  
*Info técnica en pág 338*

6005

**FONDA**

ALUMINIUM

Designer: Viefte Studio



**Finishes**  
**Acabados**

	↕
Polished chrome <i>Cromo brillo</i>	100 mm
Stainless steel look <i>Inox look</i>	150 mm
Brushed dark brass <i>Latón oscuro cepillado</i>	200 mm
Brushed black <i>Negro cepillado</i>	



Technical info on page 339  
*Info técnica en pág 339*



# TECH- NICAL *Info*

—  
Información  
técnica

—  
Informació  
tècnica



0636 **POINT** ALUMINIUM Designer: Patricia Roig

NEW!



0636 - 960

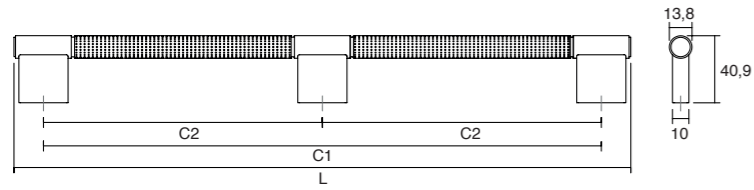

0636 - 192/320

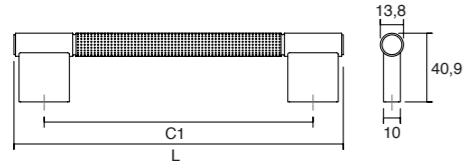

0636 - 110

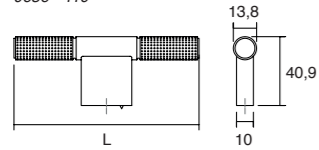

0636 - 040

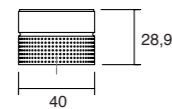

Includes non-twisting tip  
Incluye punta anti-giro

L30	L33	L618	C1	C2	L	↓	📦
Brushed black Negro cepillado	Titanium black Negro titanio	Brushed brass cava Latón cava cepillado					
0636040L30	0636040L33	0636040L618	-	-	Ø40	1	25
0636110L30	0636110L33	0636110L618	-	-	110	1	25
0636192L30	0636192L33	0636192L618	192	-	228	2	25
0636320L30	0636320L33	0636320L618	320	-	356	2	25
0636960L30	0636960L33	0636960L618	960	480	996	3	10

0635 **LIDD** ZAMAK Designer: Ilja Huber

NEW!

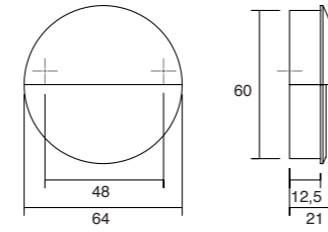
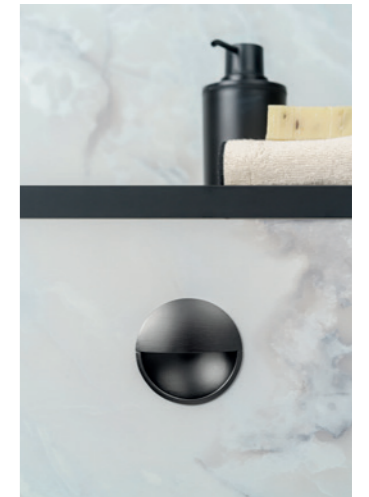

Z23	Z33	Z618	ZM1	ZM2	↓	📦
Brushed nickel Níquel cepillado	Titanium black Negro titanio	Brushed brass cava Latón cava cepillado	Matt white Blanco mate	Matt black Negro mate		
0635048Z23	0635048Z33	0635048Z618	0635048ZM1	0635048ZM2	2	25

0627 **FUSION** ZAMAK Designer: Ilja Huber

NEW!

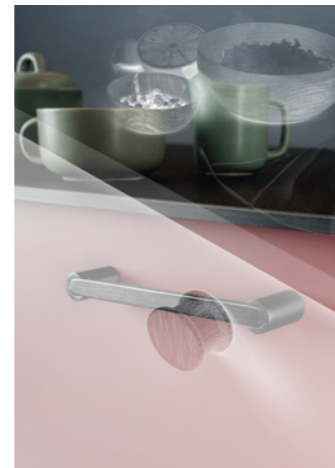

0627 - 160/320

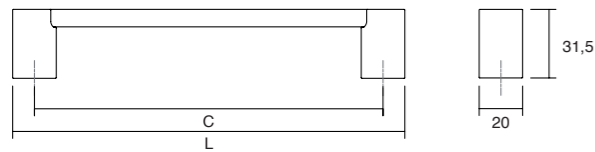

0627 - 058

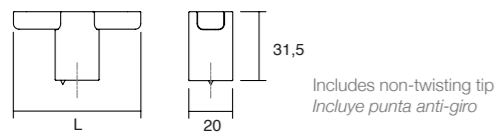

Includes non-twisting tip  
Incluye punta anti-giro

Z33	Z618	ZM2	Z03	Z05	Z07	C	L	↓	📦
Titanium black Negro titanio	Brushed brass cava Latón cava cepillado	Matt black Negro mate	Polished titanium black Titanio negro brillo	Polished nickel Níquel brillo	Polished brass Latón brillo				
0627058Z33	0627058Z618	0627058ZM2	0627058Z03	0627058Z05	0627058Z07	-	58	1	25
0627160Z33	0627160Z618	0627160ZM2	0627160Z03	0627160Z05	0627160Z07	160	180	2	25
0627320Z33	0627320Z618	0627320ZM2	0627320Z03	0627320Z05	0627320Z07	320	340	2	25

0638 **PRISM** ZAMAK Designer: Patricia Roig

NEW!

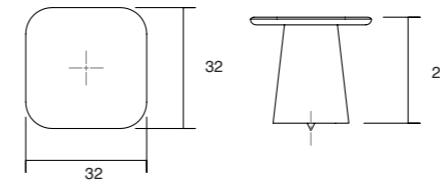
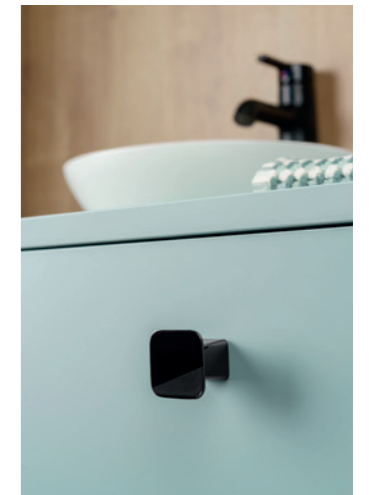

Includes non-twisting tip  
Incluye punta anti-giro

Z33	Z618	ZM1	ZM2	Z03	Z05	Z07	↓	📦
Titanium black Negro titanio	Brushed brass cava Latón cava cepillado	Matt white Blanco mate	Matt black Negro mate	Polished titanium black Titanio negro brillo	Polished nickel Níquel brillo	Polished brass Latón brillo		
0638032Z33	0638032Z618	0638032ZM1	0638032ZM2	0638032Z03	0638032Z05	0638032Z07	1	25

0643 **LINKK** ALUMINIUM Designer: Alexis Vivet

NEW!

0643 - 160/320

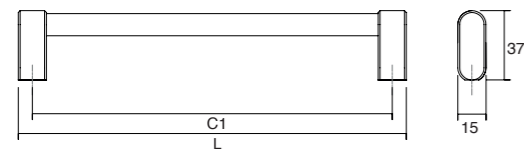

0643 - 1056

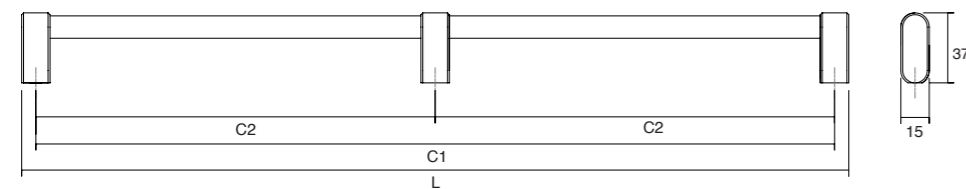

L24	L291	L30	C1	C2	L	↓	☐
Stainless steel look <i>Inox look</i>	Brushed brass <i>Latón cepillado</i>	Brushed black <i>Negro cepillado</i>					
0643160L24	0643160L291	0643160L30	160	-	175	2	25
0643320L24	0643320L291	0643320L30	320	-	335	2	25
06431056L24	06431056L291	06431056L30	1056	528	1071	3	10



0650 **MOULE** ZAMAK Designer: Kaschkasch

NEW!

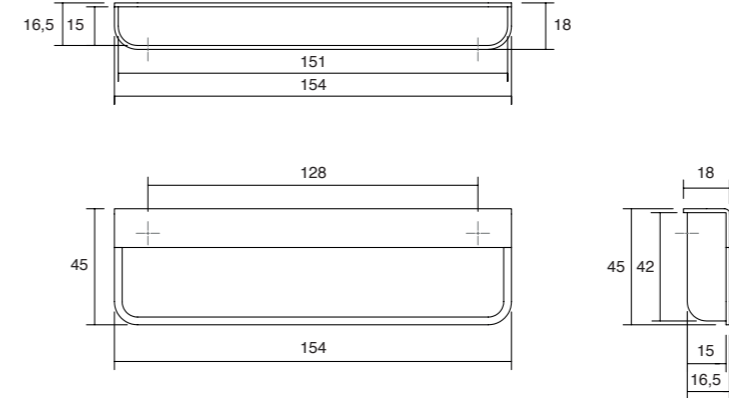

Z33	Z618	ZM1	ZM2	↓	☐
Titanium black <i>Negro titanio</i>	Brushed brass cava <i>Latón cava cepillado</i>	Matt white <i>Blanco mate</i>	Matt black <i>Negro mate</i>		
0650128Z33	0650128Z618	0650128ZM1	0650128ZM2	2	25



0648 **OMEGA** ZAMAK Designer: Kaschkasch

NEW!

0648 - 160

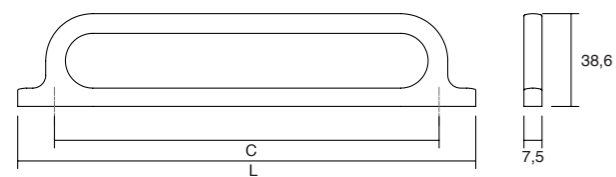

0648 - 32

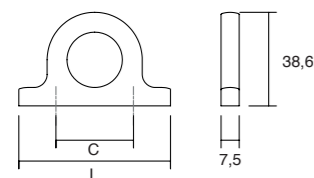

Z618	Z623	ZM2	C	L	↓	☐
Brushed brass cava <i>Latón cava cepillado</i>	Rustic brass <i>Latón rústico</i>	Matt black <i>Negro mate</i>				
0648032Z618	0648032Z623	0648032ZM2	32	62,5	2	25
0648160Z618	0648160Z623	0648160ZM2	160	190,5	2	25



0603 **LIPP** ZAMAK Designer: Alexis Vivet

NEW!

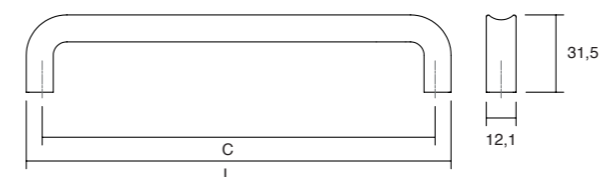

Z618	ZM2	C	L	↓	☐
Brushed brass cava <i>Latón cava cepillado</i>	Matt black <i>Negro mate</i>				
0603192Z618	0603192ZM2	192	205	2	25
0603320Z618	0603320ZM2	320	333	2	25

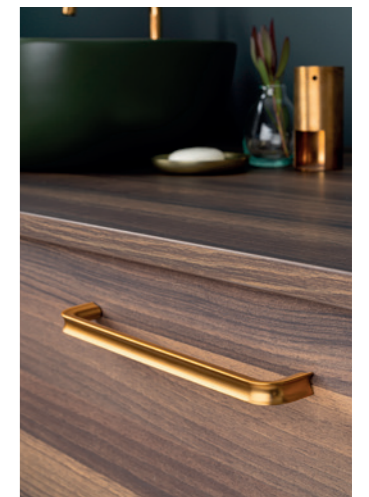

0645 **RISS mini** ALUMINIUM Designer: Kaschkasch **NEW!**

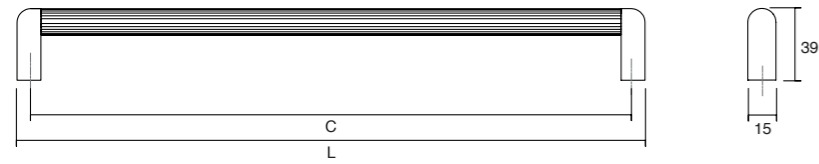

LM1	LM2	LM25	LM31	LM43	LM72	LM82	C	L	↓	☐
Matt white <i>Blanco mate</i>	Matt black <i>Negro mate</i>	Moss grey <i>Gris musgo</i>	Forest green <i>Verde forest</i>	Mocca brown <i>Marrón mocca</i>	Volcano red <i>Rojo volcano</i>	Midnight blue <i>Azul midnight</i>				
0645192LM1	0645192LM2	0645192LM25	0645192LM31	0645192LM43	0645192LM72	0645192LM82	192	207	2	25
0645320LM1	0645320LM2	0645320LM25	0645320LM31	0645320LM43	0645320LM72	0645320LM82	320	335	2	25

0657 **NOBB** ALUMINIUM Designer: Viefe Studio **NEW!**

0657 - 1056

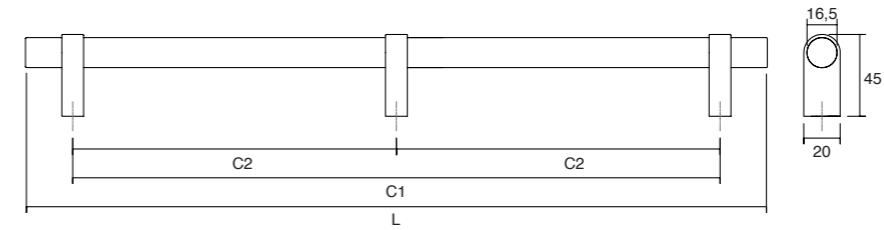

0657 - 192/320

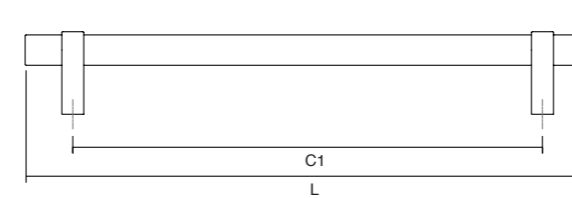

0657 - 052

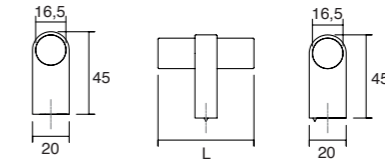

Includes non-twisting tip / Incluye punta anti-giro



L24	L618	L30	C1	C2	L	↓	☐
Stainless steel look <i>Inox look</i>	Brushed brass cava <i>Latón cava cepillado</i>	Brushed black <i>Negro cepillado</i>					
0657052L24	0657052L618	0657052L30	-	-	52	1	25
0657192L24	0657192L618	0657192L30	192	-	244	2	25
0657320L24	0657320L618	0657320L30	320	-	372	2	25
06571056L24	06571056L618	06571056L30	1056	528	1108	3	10

0655 **RISS big** ALUMINIUM Designer: Kaschkasch **NEW!**

0655 - 480

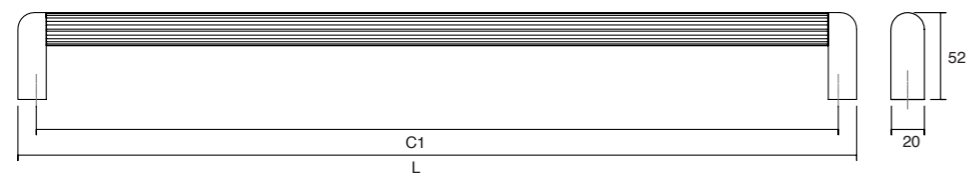

0655 - 960

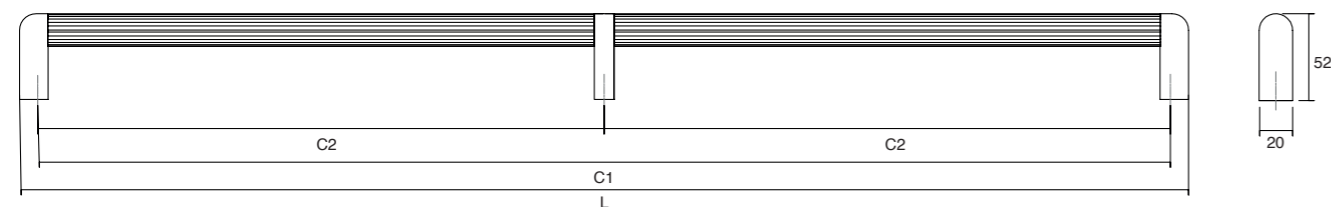

LM1	LM2	LM25	LM31	LM43	LM72	LM82	C1	C2	L	↓	☐
Matt white <i>Blanco mate</i>	Matt black <i>Negro mate</i>	Moss grey <i>Gris musgo</i>	Forest green <i>Verde forest</i>	Mocca brown <i>Marrón mocca</i>	Volcano red <i>Rojo volcano</i>	Midnight blue <i>Azul midnight</i>					
0655480LM1	0655480LM2	0655480LM25	0655480LM31	0655480LM43	0655480LM72	0655480LM82	480	-	502	2	15
0655960LM1	0655960LM2	0655960LM25	0655960LM31	0655960LM43	0655960LM72	0655960LM82	960	480	982	3	10

0629 / 0662 / 0663 **MOON** ALUMINIUM Designer: Ilja Huber **NEW!**

Available with one side system  
*Disponible con sistema de una cara*

Available with back to back system  
*Disponible con sistema de doble cara*

0629 - 384 / 0662 - 384 / 0663 - 384

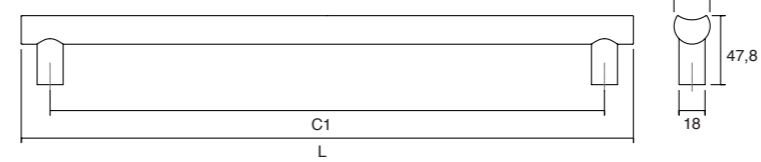

0629 - 1056 / 0662 - 1056 / 0663 - 1056

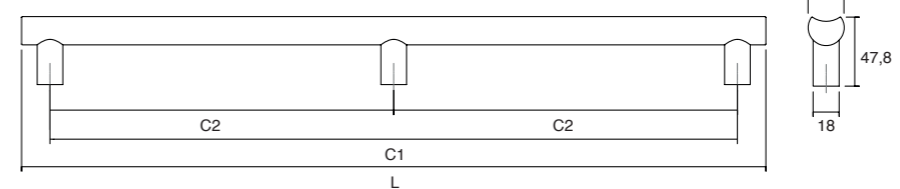

L24	L618	L30	C1	C2	L	↓	☐
Stainless steel look <i>Inox look</i>	Brushed brass cava <i>Latón cava cepillado</i>	Brushed black <i>Negro cepillado</i>					
0629384L24	0629384L618	0629384L30	384	-	424	2	15
06291056L24	06291056L618	06291056L30	1056	528	1096	3	10
0662384L24	0662384L618	0662384L30	384	-	424	2	2
06621056L24	06621056L618	06621056L30	1056	528	1096	3	2
0663384L24	0663384L618	0663384L30	384	-	424	2	1
06631056L24	06631056L618	06631056L30	1056	528	1096	3	1



0658 **DUO mini** ALUMINIUM + WOOD Designer: Ilja Huber **NEW!**

Certified wood  
Madera certificada

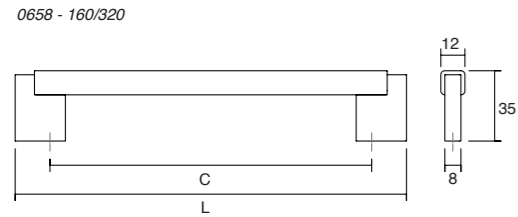

NM2716	NM2717	NM2M2	C	L	↓	☐
Lava grey + Oak Gris lava + roble	Lava grey + Walnut Gris lava + Nogal	Matt black + Oak matt black lacquered Negro mate + Roble lacado negro mate				
0658160NM2716	0658160NM2717	0658160NM2M2	160	194,6	2	25
0658320NM2716	0658320NM2717	0658320NM2M2	320	354,6	2	25

0659 / 0668 / 0670 **DUO big** ALUMINIUM + WOOD Designer: Ilja Huber **NEW!**

Available with one side system  
Disponible con sistema de una cara

Available with back to back system  
Disponible con sistema de doble cara

Certified wood  
Madera certificada

0659 - 1016 / 0668 - 1016 / 0670 - 1016

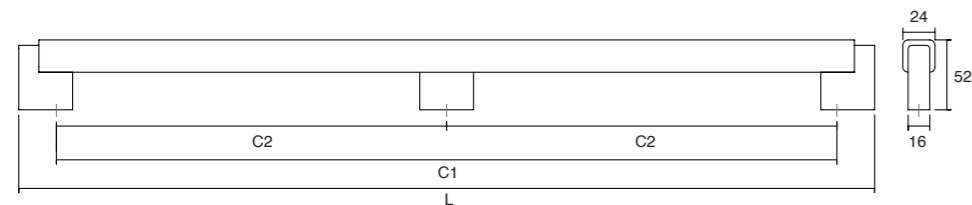

0659 - 536 / 0668 - 536 / 0670 - 536

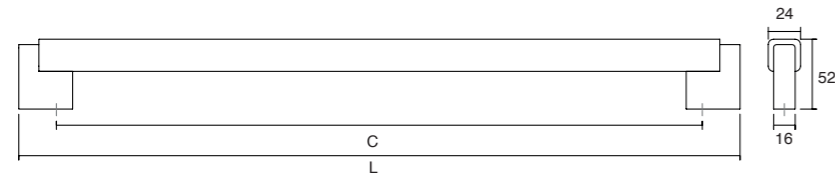

NM2716	NM2717	NM2M2	C1	C2	L	↓	☐
Lava grey + Oak Gris lava + roble	Lava grey + Walnut Gris lava + Nogal	Matt black + Oak matt black lacquered Negro mate + Roble lacado negro mate					
0659480NM2716	0659480NM2717	0659480NM2M2	480	-	536	2	2
0659960NM2716	0659960NM2717	0659960NM2M2	960	480	1016	3	2
0668480NM2716	0668480NM2717	0668480NM2M2	480	-	536	2	2
0668960NM2716	0668960NM2717	0668960NM2M2	960	480	1016	3	2
0670480NM2716	0670480NM2717	0670480NM2M2	480	-	536	2	1
0670960NM2716	0670960NM2717	0670960NM2M2	960	480	1016	3	1

0664 / 0665 / 0671 **LUV WOOD** WOOD Designer: Kaschkasch **NEW!**

Available with one side system  
Disponible con sistema de una cara

Available with back to back system  
Disponible con sistema de doble cara

Certified wood  
Madera certificada

0664 - 992 / 0665 - 992 / 0671 - 992

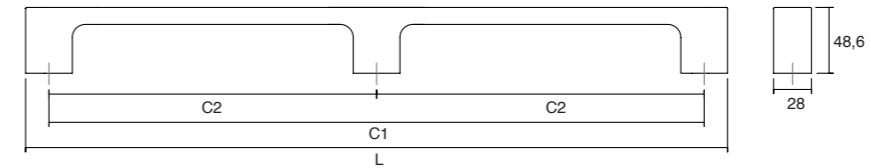

0664 - 384 / 0665 - 384 / 0671 - 384

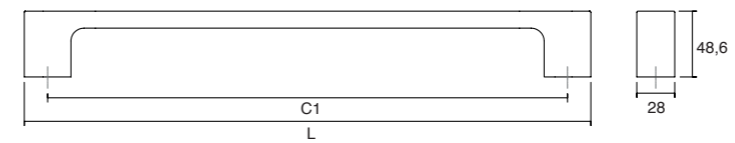

W16	W17	WM2	C1	C2	L	↓	☐
Oak Roble	Walnut Nogal	Oak matt black lacquered Roble lacado negro mate					
0664384W16	0664384W17	0664384WM2	384	-	418,5	2	2
0664992W16	0664992W17	0664992WM2	992	496	1026,5	3	2
0665384W16	0665384W17	0665384WM2	384	-	418,5	2	2
0665992W16	0665992W17	0665992WM2	992	496	1026,5	3	2
0671384W16	0671384W17	0671384WM2	384	-	418,5	2	1
0671992W16	0671992W17	0671992WM2	992	496	1026,5	3	1



0536 **LUV** ZAMAK Designer: Kaschkasch

0536 - 192 / 320

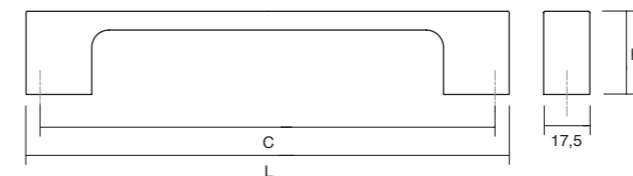

0536 - 017

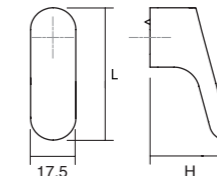

Includes non-twisting tip  
Incluye punta anti-giro

Z23	Z618	ZM1	ZM2	C	L	H	↓	☐
Brushed nickel Níquel cepillado	Brushed brass cava Latón cava cepillado	Matt white Blanco mate	Matt black Negro mate					
0536017Z23	0536017Z618	0536017ZM1	0536017ZM2	-	51,2	31,1	1	25
0536192Z23	0536192Z618	0536192ZM1	0536192ZM2	192	202	30,4	2	25
0536320Z23	0536320Z618	0536320ZM1	0536320ZM2	320	330	30,4	2	25

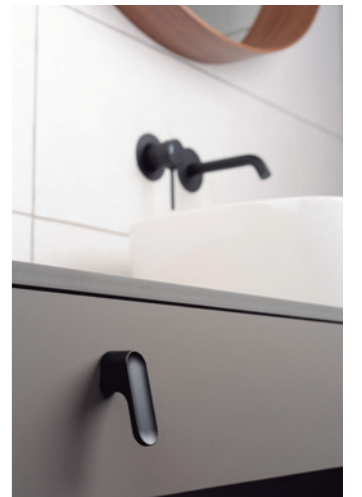

0621 **RILLE mini** ALUMINIUM Designer: Patricia Roig

NEW!



0621 - 160/320

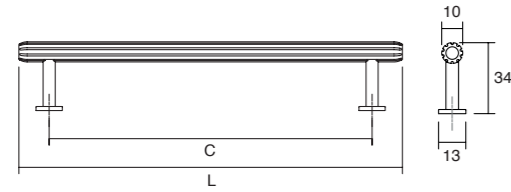

0621 - 055

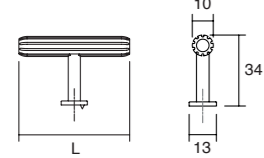

Includes non-twisting tip  
Incluye punta anti-giro

L05	L24	L291	L30	C	L	↓	☐
Polished nickel Níquel brillo	Stainless steel look Inox look	Brushed brass Latón cepillado	Brushed black Negro cepillado				
0621055L05	0621055L24	0621055L291	0621055L30	-	55	1	25
0621160L05	0621160L24	0621160L291	0621160L30	160	190	2	25
0621320L05	0621320L24	0621320L291	0621320L30	320	350	2	25

0487 **PURA** ZAMAK Designer: Balutto Associati

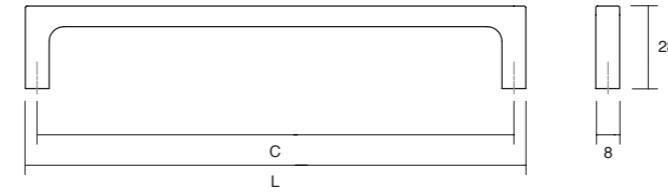
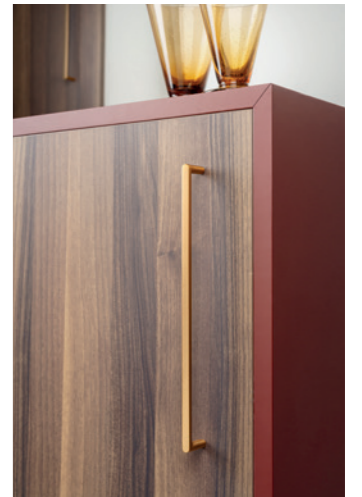

Z01	Z03	Z06	Z07	NEW!	NEW!	NEW!	C	L	↓	☐
Polished chrome Cromo brillo	Polished titanium black Titanio negro brillo	Polished copper Cobre brillo	Polished brass Latón brillo	Brushed nickel Níquel cepillado	Brushed brass cava Latón cava cepillado	Matt black Negro mate				
0487160Z01	0487160Z03	0487160Z06	0487160Z07	0487160Z23	0487160Z618	0487160ZM2	160	168	2	25
NEW! 0487256Z01	0487256Z03	0487256Z06	0487256Z07	0487256Z23	0487256Z618	0487256ZM2	256	264	2	25

0528 **RILLE** ALUMINIUM Designer: Patricia Roig



0528 - 160 / 320 / 480

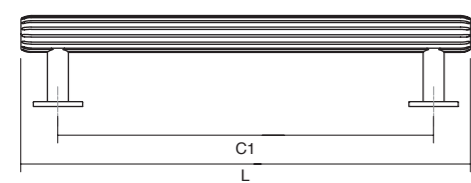

0528 - 055

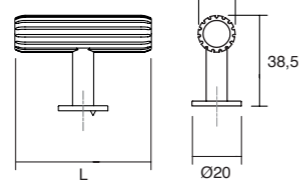

Includes non-twisting tip  
Incluye punta anti-giro

0528 - 992

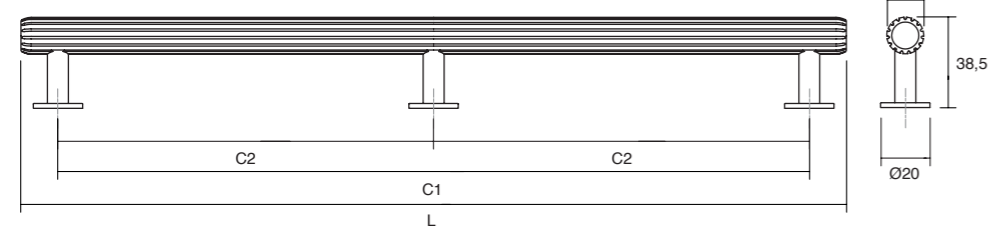

L24	L291	L30	C1	C2	L	↓	☐
Stainless steel look Inox look	Brushed brass Latón cepillado	Brushed black Negro cepillado					
0528055L24	0528055L291	0528055L30	-	-	55	1	25
0528160L24	0528160L291	0528160L30	160	-	190	2	25
0528320L24	0528320L291	0528320L30	320	-	350	2	25
0528480L24	0528480L291	0528480L30	480	-	510	2	25
0528992L24	0528992L291	0528992L30	992	496	1022	3	15

0590 **BELT** ZAMAK Designer: Kaschkasch



0590 - 160

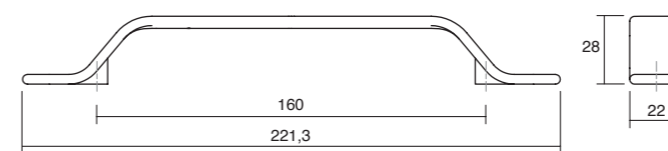

0590 - 022

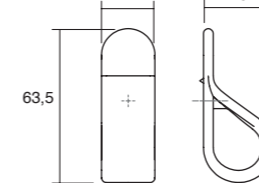

Includes non-twisting tip / Incluye punta anti-giro

ZM1	ZM2	ZM25	ZM31	ZM43	ZM72	↓	☐
Matt white Blanco mate	Matt black Negro mate	Moss grey Gris musgo	Forest green Verde forest	Mocca brown Marrón mocca	Volcano red Rojo volcano		
0590022ZM1	0590022ZM2	0590022ZM25	0590022ZM31	0590022ZM43	0590022ZM72	1	25
0590160ZM1	0590160ZM2	0590160ZM25	0590160ZM31	0590160ZM43	0590160ZM72	2	25

0597 **PLIÉ** ZAMAK Designer: Teruel & Paré

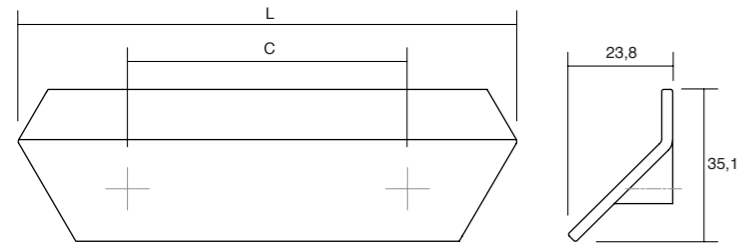

ZM2	ZM23	ZM41	C	L	↓	☐
Matt black	Metal grey	Metal brown				
Negro mate	Gris metal	Marrón metal				
0597064ZM2	0597064ZM23	0597064ZM41	64	114	2	25
0597160ZM2	0597160ZM23	0597160ZM41	160	210	2	25

0591 **ETO** ALUMINIUM + WOOD Designer: Kaschkasch

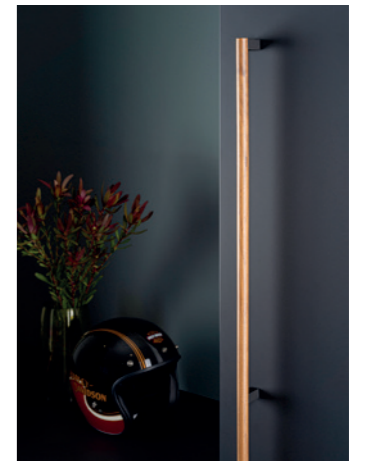
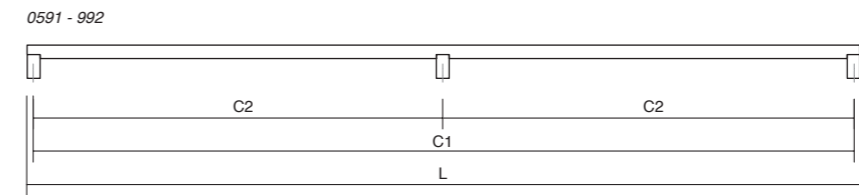
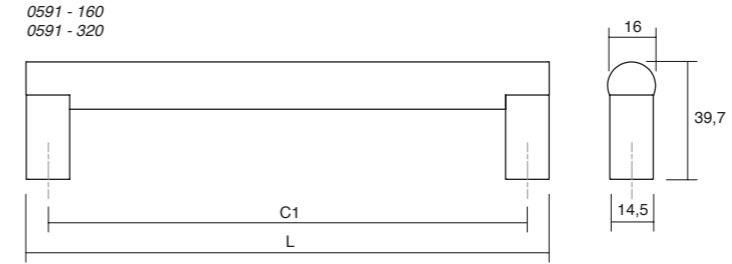

NM2716	NM2717	NM2M2	C1	C2	L	↓	☐
Lava grey + Oak	Lava grey + Walnut	Matt black + Ash matt black lacquered					
Gris lava + roble	Gris lava + Nogal	Negro mate + Fresno lacado negro mate					
0591160NM2716	0591160NM2717	0591160NM2M2	160	-	174,6	2	25
0591320NM2716	0591320NM2717	0591320NM2M2	320	-	334,6	2	25
0591992NM2716	0591992NM2717	0591992NM2M2	992	496	1006,6	3	15

0600 **WING** ALUMINIUM Designer: Alexis Vivet

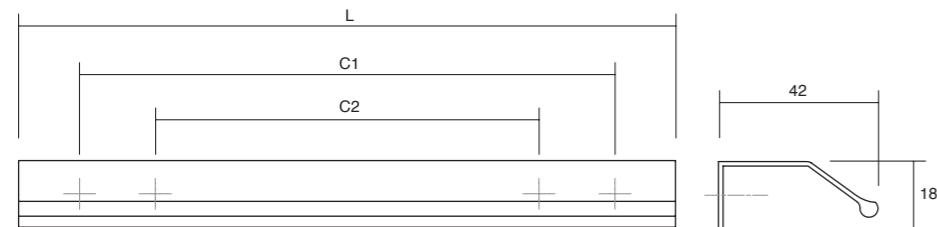

L24	L30	L613	L618	C1	C2	L	↓	☐
Stainless steel look	Brushed black	Antique bronze	Brushed brass cava					
Inox look	Negro cepillado	Bronce antiguo	Latón cava cepillado					
0600064L24	0600064L30	0600064L613	0600064L618	64	-	100	2	25
0600128L24	0600128L30	0600128L613	0600128L618	128	-	200	2	25
0600256L24	0600256L30	0600256L613	0600256L618	256	-	350	2	25
06001120L24	06001120L30	06001120L613	06001120L618	1120	384	1200	4	15



0610 **FLAPP Aluminium** ALUMINIUM Designer: Frank Person

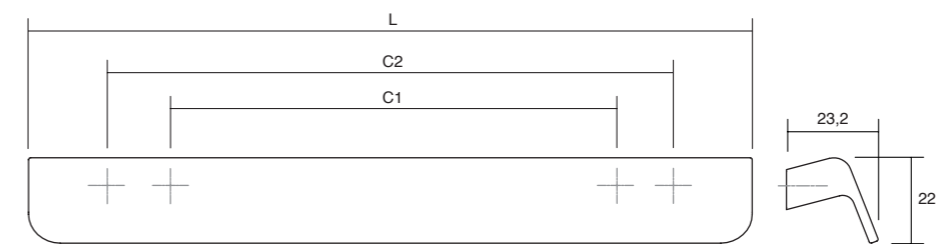

L24	L30	L618	C1	C2	L	↓	☐
Stainless steel look	Brushed black	Brushed brass cava					
Inox look	Negro cepillado	Latón cava cepillado					
0610032L24	0610032L30	0610032L618	32	-	70	2	25
0610160L24	0610160L30	0610160L618	128	160	200	4	25
0610256L24	0610256L30	0610256L618	256	-	350	2	25
06101056L24	06101056L30	06101056L618	416	1056	1100	4	15



0613 **FLAPP Wood**

WOOD

Designer: Frank Person

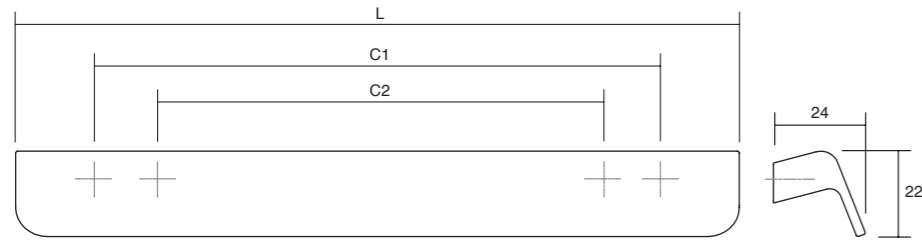

NEW!			C1	C2	L	↓	☐
<b>W16</b> Oak Roble	<b>W17</b> Walnut Nogal	<b>W00</b> Oak raw Roble crudo					
0613032W16	0613032W17	0613032W00	32	-	70	2	25
0613160W16	0613160W17	0613160W00	160	-	200	2	25
06131056W16	06131056W17	06131056W00	1056	416	1100	4	15

0601 **OH! Wood**

WOOD

Designer: Alexis Vivet

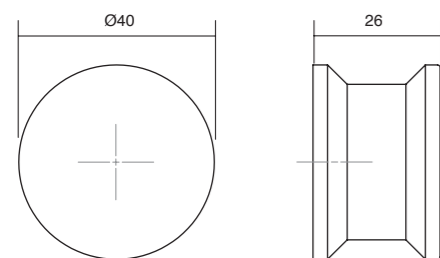

W16	W17	WM2	↓	☐
Oak Roble	Walnut Nogal	Ash matt black lacquered Fresno lacado negro mate		
0601040W16	0601040W17	0601040WM2	1	25

0601 **OH! Zamak**

ZAMAK

Designer: Alexis Vivet

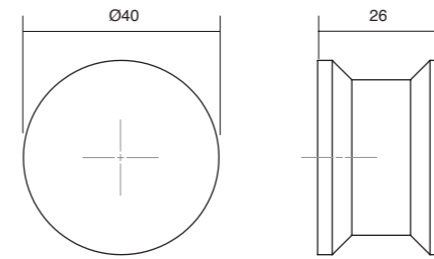

Z23	Z618	ZM2	↓	☐
Brushed nickel Níquel cepillado	Brushed brass cava Latón cava cepillado	Matt black Negro mate		
0601040Z23	0601040Z618	0601040ZM2	1	25

0602 **VALLEY**

ZAMAK

Designer: Alexis Vivet

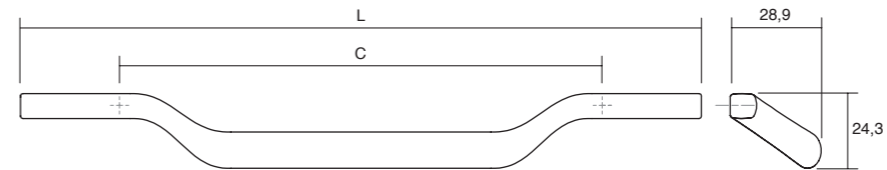

Z03	Z07	Z618	ZM2	C	L	↓	☐
Polished titanium black Titanio negro brillo	Polished brass Latón brillo	Brushed brass cava Latón cava cepillado	Matt black Negro mate				
0602160Z03	0602160Z07	0602160Z618	0602160ZM2	160	223	2	25
0602256Z03	0602256Z07	0602256Z618	0602256ZM2	256	330	2	25

0604 **PRISMA**

ZAMAK

Designer: Alexis Vivet

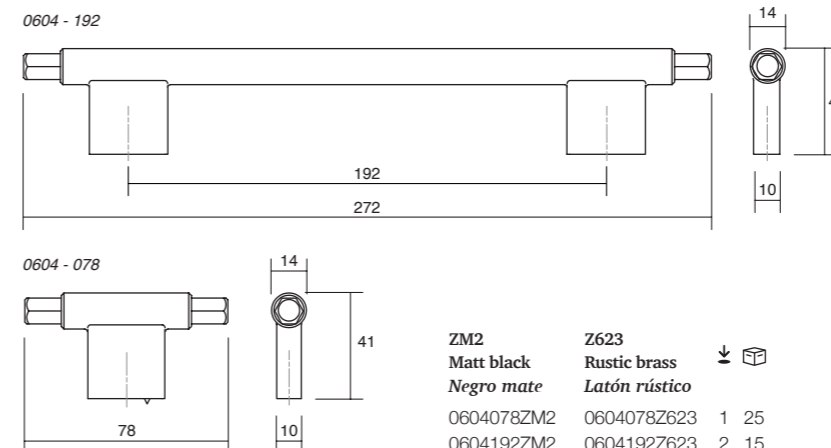

ZM2	Z623	↓	☐
Matt black Negro mate	Rustic brass Latón rústico		
0604078ZM2	0604078Z623	1	25
0604192ZM2	0604192Z623	2	15

Includes non-twisting tip  
Incluye punta anti-giro

0608 **QUART Mini** ZAMAK Designer: Frank Person

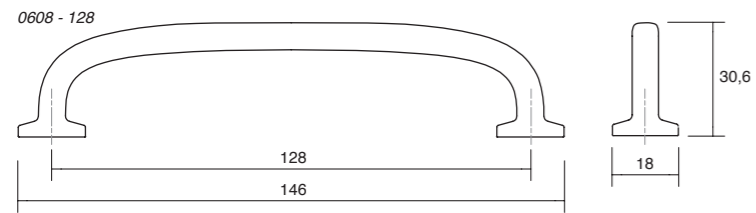

0608 - 026

Z618	Z623	ZM2		
Brushed brass cava	Rustic brass	Matt black	↓	📦
<i>Latón cava cepillado</i>	<i>Latón rústico</i>	<i>Negro mate</i>		
0608026Z618	0608026Z623	0608026ZM2	1	25
0608128Z618	0608128Z623	0608128ZM2	2	25

Includes non-twisting tip  
Incluye punta anti-giro



0530 **DISC** WOOD Designer: Balutto Associati

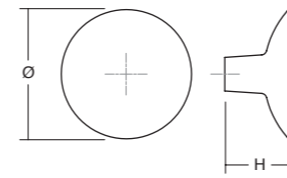

W16	W17	WM2	Ø	H	↓	📦
Oak	Walnut	Ash matt black lacquered				
<i>Roble</i>	<i>Nogal</i>	<i>Fresno lacado negro mate</i>				
0530038W16	0530038W17	0530038WM2	38	20,4	1	25
0530050W16	0530050W17	0530050WM2	50	27	1	25



0616 **QUART Big** ZAMAK Designer: Frank Person

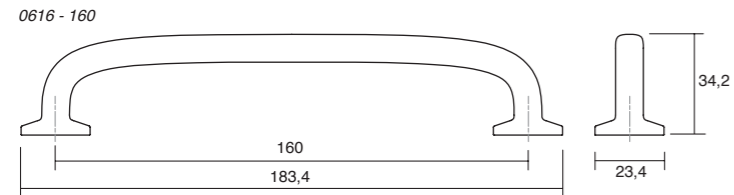

0616 - 034

Z618	Z623	ZM2		
Brushed brass cava	Rustic brass	Matt black	↓	📦
<i>Latón cava cepillado</i>	<i>Latón rústico</i>	<i>Negro mate</i>		
0616034Z618	0616034Z623	0616034ZM2	1	25
0616160Z618	0616160Z623	0616160ZM2	2	25

Includes non-twisting tip  
Incluye punta anti-giro



0530 **DISC** ZAMAK Designer: Balutto Associati

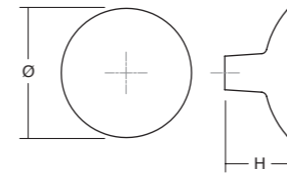

Z23	Z618	ZM1	ZM2	Ø	H	↓	📦
Brushed nickel	Brushed brass cava	Matt white	Matt black				
<i>Níquel cepillado</i>	<i>Latón cava cepillado</i>	<i>Blanco mate</i>	<i>Negro mate</i>				
0530038Z23	0530038Z618	0530038ZM1	0530038ZM2	38	20,4	1	25
0530050Z23	0530050Z618	0530050ZM1	0530050ZM2	50	27	1	25

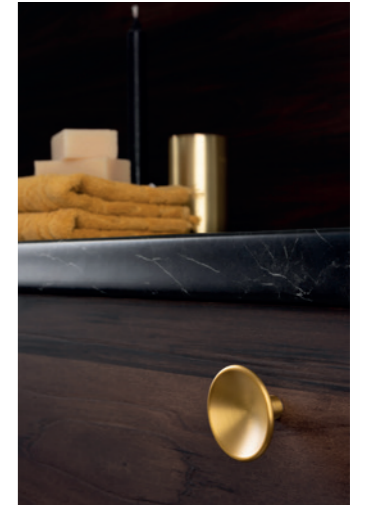

0614 **EQUIS** ZAMAK Designer: Patricia Roig

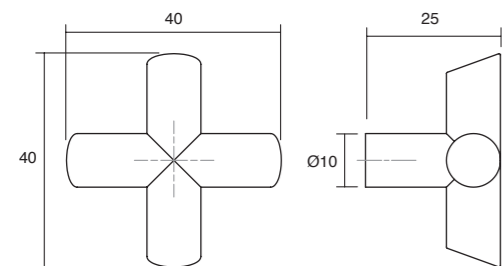

Z01	Z03	Z06	Z07	ZM1	ZM2		
Polished chrome	Polished titanium black	Polished copper	Polished brass	Matt white	Matt black	↓	📦
<i>Cromo brillo</i>	<i>Titanio negro brillo</i>	<i>Cobre brillo</i>	<i>Latón brillo</i>	<i>Blanco mate</i>	<i>Negro mate</i>		
0614040Z01	0614040Z03	0614040Z06	0614040Z07	0614040ZM1	0614040ZM2	1	25



0538 **CONIC** WOOD Designer: Kaschkasch

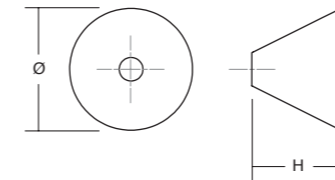

W16	W17	WM2	Ø	H	↓	📦
Oak	Walnut	Ash matt black lacquered				
<i>Roble</i>	<i>Nogal</i>	<i>Fresno lacado negro mate</i>				
0538029W16	0538029W17	0538029WM2	29,4	22	1	25
0538043W16	0538043W17	0538043WM2	43	25	1	25

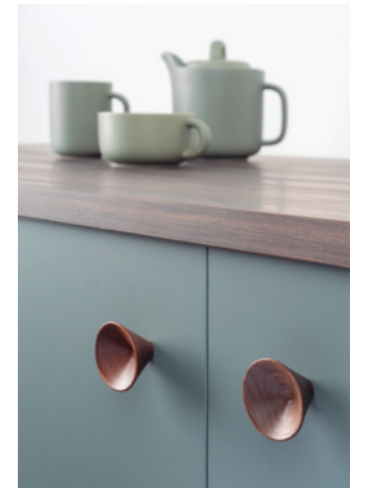



0538 **CONIC** ZAMAK Designer: Kaschkasch

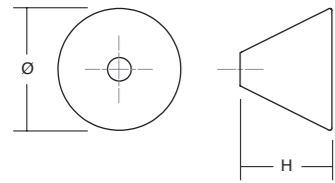

ZM1	ZM2	ZM25	Ø	H	↓	☐
Matt white <i>Blanco mate</i>	Matt black <i>Negro mate</i>	Moss grey <i>Gris musgo</i>				
0538029ZM1	0538029ZM2	0538029ZM25	29,4	22	1	25
0538043ZM1	0538043ZM2	0538043ZM25	43	25	1	25



0552 **RIM** ZAMAK Designer: Bernat Lonch

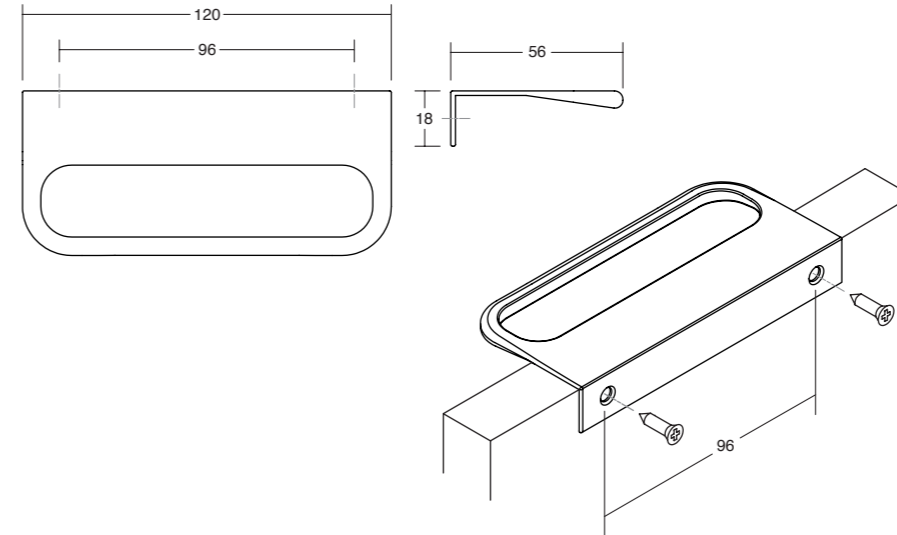

0556 **DIPO** ZAMAK Designer: Bernat Lonch

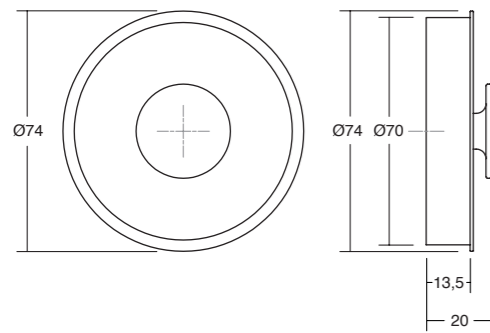

ZM1	ZM2	ZM25	↓	☐
Matt white <i>Blanco mate</i>	Matt black <i>Negro mate</i>	Moss grey <i>Gris musgo</i>		
0556070ZM1	0556070ZM2	0556070ZM25	1	25



Z23	Z618	ZM1	ZM2	ZM25	↓	☐
Brushed nickel <i>Níquel cepillado</i>	Brushed brass cava <i>Latón cava cepillado</i>	Matt white <i>Blanco mate</i>	Matt black <i>Negro mate</i>	Moss grey <i>Gris musgo</i>		
0552096Z23	0552096Z618	0552096ZM1	0552096ZM2	0552096ZM25	2	25

0543 **SOFT** ZAMAK Designer: Uli Budde

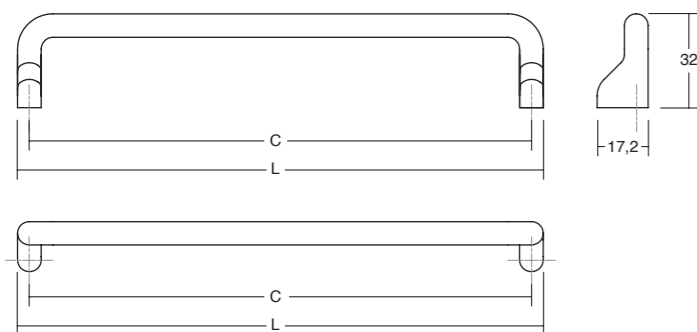

ZM1	ZM2	ZM25	C	L	↓	☐
Matt white <i>Blanco mate</i>	Matt black <i>Negro mate</i>	Moss grey <i>Gris musgo</i>				
0543032ZM1	0543032ZM2	0543032ZM25	32	40	2	25
0543192ZM1	0543192ZM2	0543192ZM25	192	200	2	25
0543320ZM1	0543320ZM2	0543320ZM25	320	328	2	25



0553 **OTO** ZAMAK Designer: Bernat Lonch

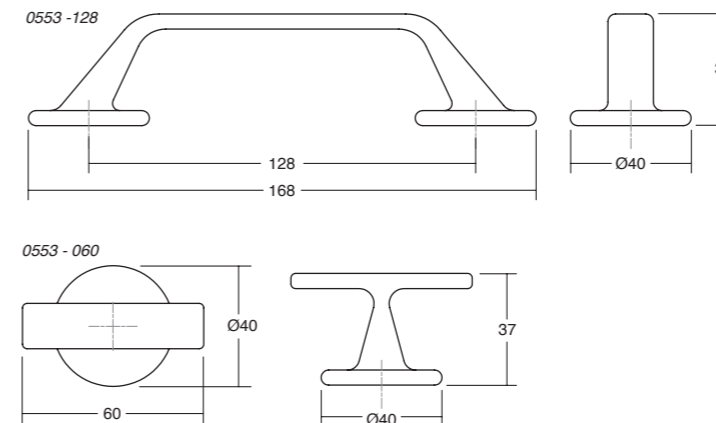

ZM22	↓	☐
Black textured <i>Negro texturizado</i>		
0553060ZM22	1	25
0553128ZM22	2	25

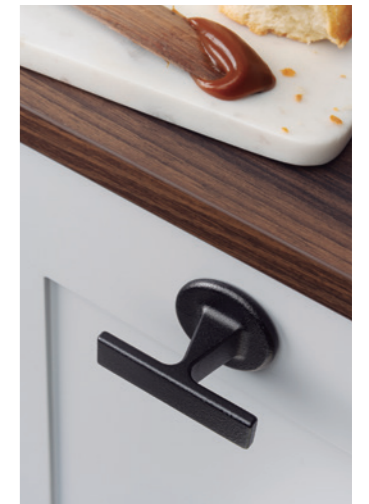

0542 **FOLD** ZAMAK Designer: Teruel & Paré

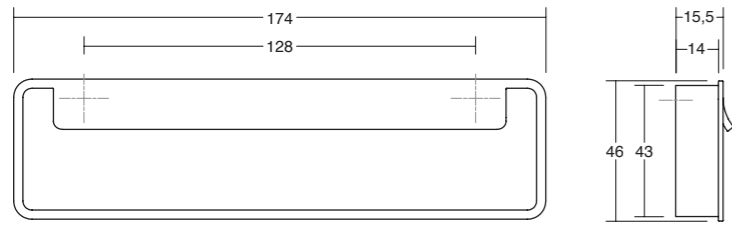

Z23	Z618	ZM1	ZM2	↓	☐
Brushed nickel	Brushed brass cava	Matt white	Matt black		
<i>Níquel cepillado</i>	<i>Latón cava cepillado</i>	<i>Blanco mate</i>	<i>Negro mate</i>		
0542128Z23	0542128Z618	0542128ZM1	0542128ZM2	2	25

0588 **ARPA PLATE** ALUMINIUM Designer: Viefe Studio

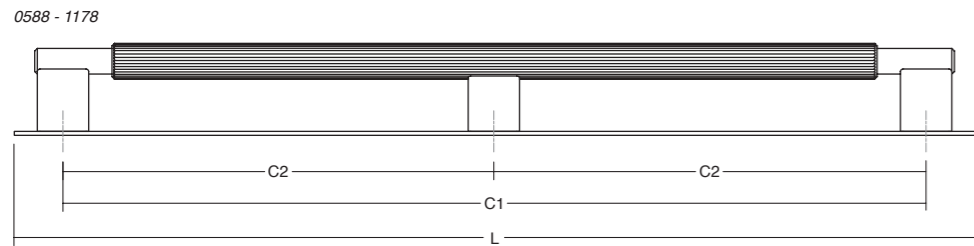
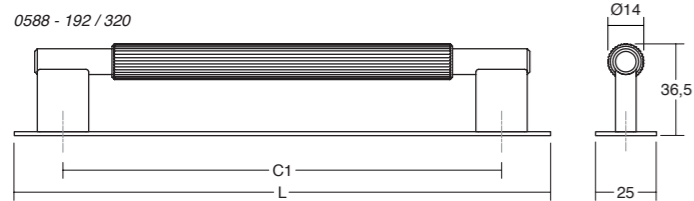

L24	L291	L30	L623	C1	C2	L	Ø	↓	☐
Stainless steel look	Brushed brass	Brushed black	Antique brass						
<i>Inox look</i>	<i>Latón cepillado</i>	<i>Negro cepillado</i>	<i>Latón antiguo</i>						
0588022L24	0588022L291	0588022L30	0588022L623	-	-	100	22	1	25
0588070L24	0588070L291	0588070L30	0588070L623	-	-	70	-	1	25
0588192L24	0588192L291	0588192L30	0588192L623	192	-	230	-	2	25
0588320L24	0588320L291	0588320L30	-	320	-	358	-	2	25
05881178L24	05881178L291	05881178L30	-	1178	589	1216	-	3	10

0583 **ARPA** ALUMINIUM Designer: Viefe Studio

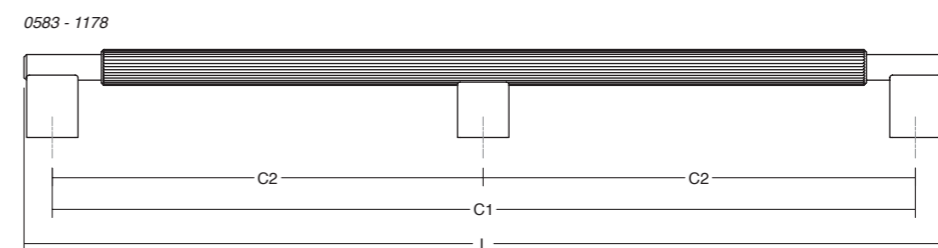
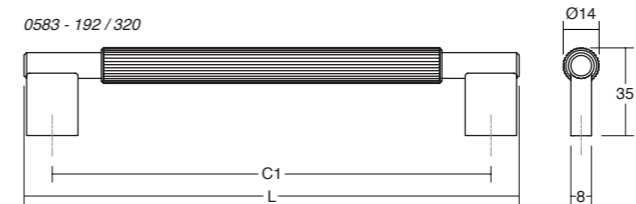
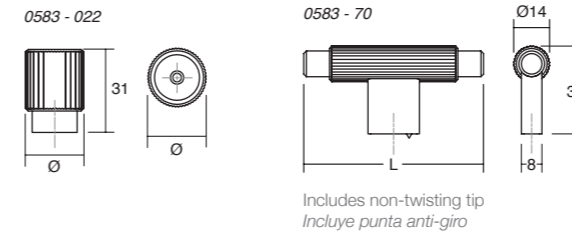

Includes non-twisting tip  
Incluye punta anti-giro

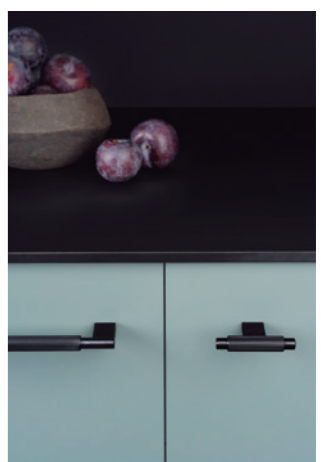

L24	L291	L30	L623	C1	C2	L	Ø	↓	☐
Stainless stl. look	Brushed brass	Brushed black	Rustic brass						
<i>Inox look</i>	<i>Latón cepillado</i>	<i>Negro cepillado</i>	<i>Latón rústico</i>						
0583022L24	0583022L291	0583022L30	0583022L623	-	-	-	22	1	25
0583070L24	0583070L291	0583070L30	0583070L623	-	-	70	-	1	25
0583192L24	0583192L291	0583192L30	0583192L623	192	-	214	-	2	25
0583320L24	0583320L291	0583320L30	-	320	-	342	-	2	25
05831178L24	05831178L291	05831178L30	-	1178	589	1200	-	3	10

0495 **FLOID** ZAMAK Designer: Frank Person

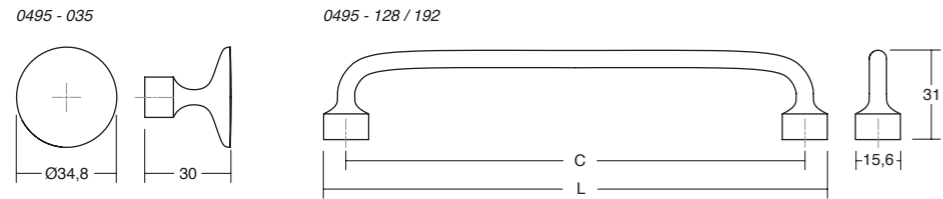

Z28	Z610	Z614	ZM2	C	L	↓	☐
Brushed gold Oro cepillado	Pewter Peltre	Antique brass Latón antiguo	Matt black Negro mate				
0495035Z28	0495035Z610	0495035Z614	0495035ZM2	-	-	1	25
0495128Z28	0495128Z610	0495128Z614	0495128ZM2	128	143,6	2	25
0495192Z28	0495192Z610	0495192Z614	0495192ZM2	192	207,6	2	25



0127 **JEY** ALUMINIUM Designer: Viefe Studio

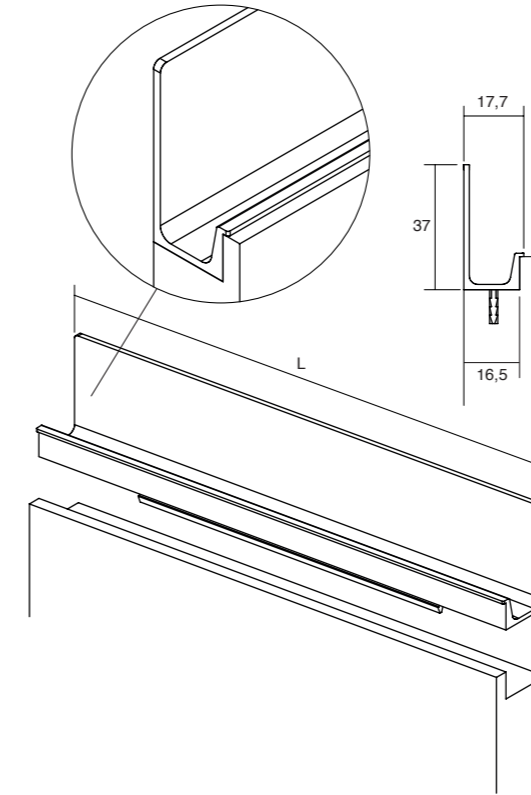

L24	L618	LM1	LM2	L	☐
Stainless steel look Inox look	Brushed brass cava Latón cava cepillado	Matt white Blanco mate	Matt black Negro mate		
0127147L24	0127147L618	0127147LM1	0127147LM2	147	15
0127197L24	0127197L618	0127197LM1	0127197LM2	197	15
0127247L24	0127247L618	0127247LM1	0127247LM2	247	15
0127297L24	0127297L618	0127297LM1	0127297LM2	297	15
0127347L24	0127347L618	0127347LM1	0127347LM2	347	15
0127397L24	0127397L618	0127397LM1	0127397LM2	397	15
0127447L24	0127447L618	0127447LM1	0127447LM2	447	10
0127497L24	0127497L618	0127497LM1	0127497LM2	497	10
0127597L24	0127597L618	0127597LM1	0127597LM2	597	10
0127697L24	0127697L618	0127697LM1	0127697LM2	697	10
0127797L24	0127797L618	0127797LM1	0127797LM2	797	10
0127897L24	0127897L618	0127897LM1	0127897LM2	897	5
0127997L24	0127997L618	0127997LM1	0127997LM2	997	5
01271197L24	01271197L618	01271197LM1	01271197LM2	1197	5
-	-	01273000LM1	01273000LM2	3000	15 *

\*Available only in M1 and M2 finishes. Three metre profiles are delivered according to the units of the original packaging and cannot be sold separately. / Disponible solo en los acabados M1 y M2. Las barras de tres metros se sirven según las cantidades del embalaje original y no se pueden servir por separado.

0496 **BAU** ZAMAK Designer: Patricia Roig

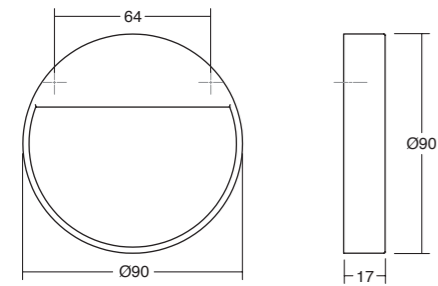

Z23	Z28	ZM2	↓	☐
Brushed nickel Níquel cepillado	Brushed gold Oro cepillado	Matt black Negro mate		
0496064Z23	0496064Z28	0496064ZM2	2	25

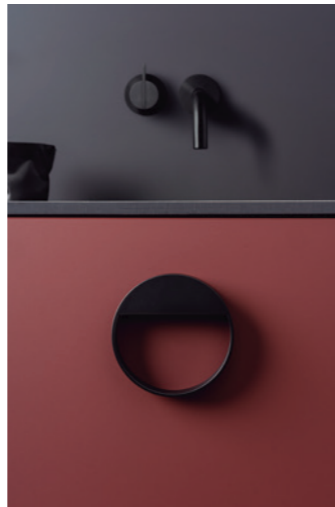

0163 **JEY2** ALUMINIUM Designer: Viefe Studio

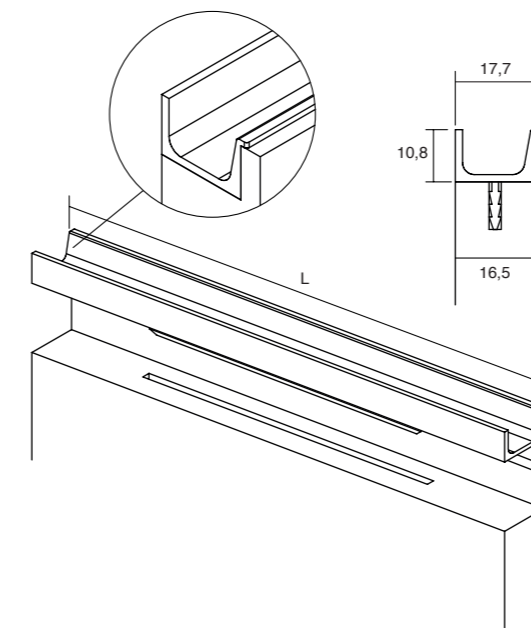

L24	L618	LM1	LM2	L	☐
Stainless steel look Inox look	Brushed brass cava Latón cava cepillado	Matt white Blanco mate	Matt black Negro mate		
0163147L24	0163147L618	0163147LM1	0163147LM2	147	15
0163197L24	0163197L618	0163197LM1	0163197LM2	197	15
0163247L24	0163247L618	0163247LM1	0163247LM2	247	15
0163297L24	0163297L618	0163297LM1	0163297LM2	297	15
0163347L24	0163347L618	0163347LM1	0163347LM2	347	15
0163397L24	0163397L618	0163397LM1	0163397LM2	397	15
0163447L24	0163447L618	0163447LM1	0163447LM2	447	10
0163497L24	0163497L618	0163497LM1	0163497LM2	497	10
0163597L24	0163597L618	0163597LM1	0163597LM2	597	10
0163697L24	0163697L618	0163697LM1	0163697LM2	697	10
0163797L24	0163797L618	0163797LM1	0163797LM2	797	10
0163897L24	0163897L618	0163897LM1	0163897LM2	897	5
0163997L24	0163997L618	0163997LM1	0163997LM2	997	5
01631197L24	01631197L618	01631197LM1	01631197LM2	1197	5
-	-	01633000LM1	01633000LM2	3000	15 *

\*Available only in M1 and M2 finishes. Three metre profiles are delivered according to the units of the original packaging and cannot be sold separately. / Disponible solo en los acabados M1 y M2. Las barras de tres metros se sirven según las cantidades del embalaje original y no se pueden servir por separado.

0168 **COMO** ZAMAK Designer: Viefe Studio

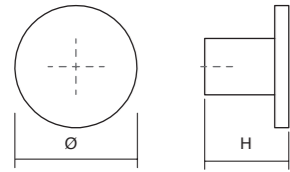

Z01	Z03	Z06	Z07	Z11	Z23	Z26	Z28	ZM1	ZM2	Ø	H	↓	☐
Polished chrome	Polished titanium black	Polished copper	Polished brass	Matt chrome	Brushed nickel	Brushed copper	Brushed gold	Matt white	Matt black				
Cromo brillo	Titanio negro brillo	Cobre brillo	Latón brillo	Cromo mate	Níquel cepillado	Cobre cepillado	Oro cepillado	Blanco mate	Negro mate				
0168026Z01	0168026Z03	0168026Z06	0168026Z07	0168026Z11	0168026Z23	0168026Z26	0168026Z28	0168026ZM1	0168026ZM2	26	18	1	25
0168041Z01	0168041Z03	0168041Z06	0168041Z07	0168041Z11	0168041Z23	0168041Z26	0168041Z28	0168041ZM1	0168041ZM2	41	25	1	25

0497 **DIABOLO** ALUMINIUM Designer: Frank Person

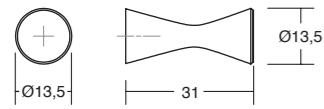

L24	L291	L30	L31	↓	☐
Stainless steel look	Brushed brass	Brushed black	Brushed grey		
Inox look	Latón cepillado	Negro cepillado	Gris cepillado		
0497014L24	0497014L291	0497014L30	0497014L31	1	25

0499 **ROUND** ALUMINIUM Designer: Balutto Associati

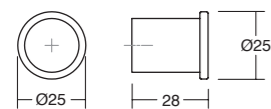

L24	L291	L30	↓	☐
Stainless steel look	Brushed brass	Brushed black		
Inox look	Latón cepillado	Negro cepillado		
0499025L24	0499025L291	0499025L30	1	25

0518 **WAY** ALUMINIUM Designer: Viefe Studio

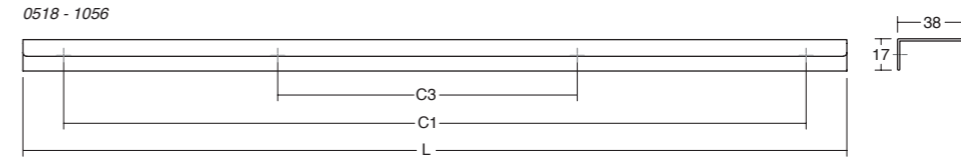
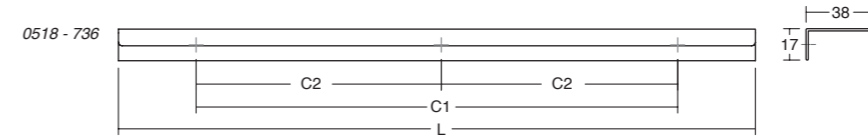
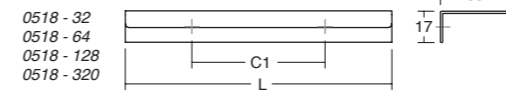

L04	L09	L24	L29	LM1	C1	C2	C3	L	↓	☐
Anodized matt	Matt black	Stainless steel look	Brushed dark brass	Matt White						
Anodizado mate	Negro mate	Inox look	Latón oscuro cepillado	Blanco mate						
0518032L04	0518032L09	0518032L24	0518032L29	0518032LM1	32	-	-	50	2	25
0518064L04	0518064L09	0518064L24	0518064L29	0518064LM1	64	-	-	100	2	25
0518128L04	0518128L09	0518128L24	0518128L29	0518128LM1	128	-	-	200	2	25
0518320L04	0518320L09	0518320L24	0518320L29	0518320LM1	320	-	-	400	2	25
0518736L04	0518736L09	0518736L24	0518736L29	0518736LM1	736	368	-	800	3	25
05181056L04	05181056L09	05181056L24	05181056L29	05181056LM1	1056	-	352	1100	4	15

0489 **BOL** ZAMAK / WOOD Designer: Balutto Associati

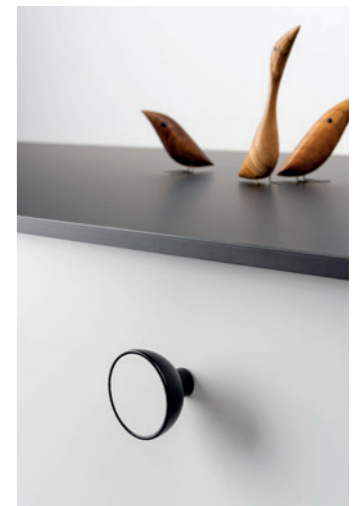
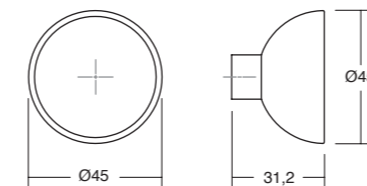

NM222 (ZM2+W22)	NM223 (ZM2+W23)	NM2M1 (ZM2+WM1)	↓	☐
Matt black + Sapelli	Matt black + Beech	Matt black + Matt white lacquered		
Negro mate + Sapelli	Negro mate + Haya	Negro mate + Lacado blanco mate		
0489045NM222	0489045NM223	0489045NM2M1	1	25

0511 **RAIL** ALUMINIUM Designer: Teruel & Paré

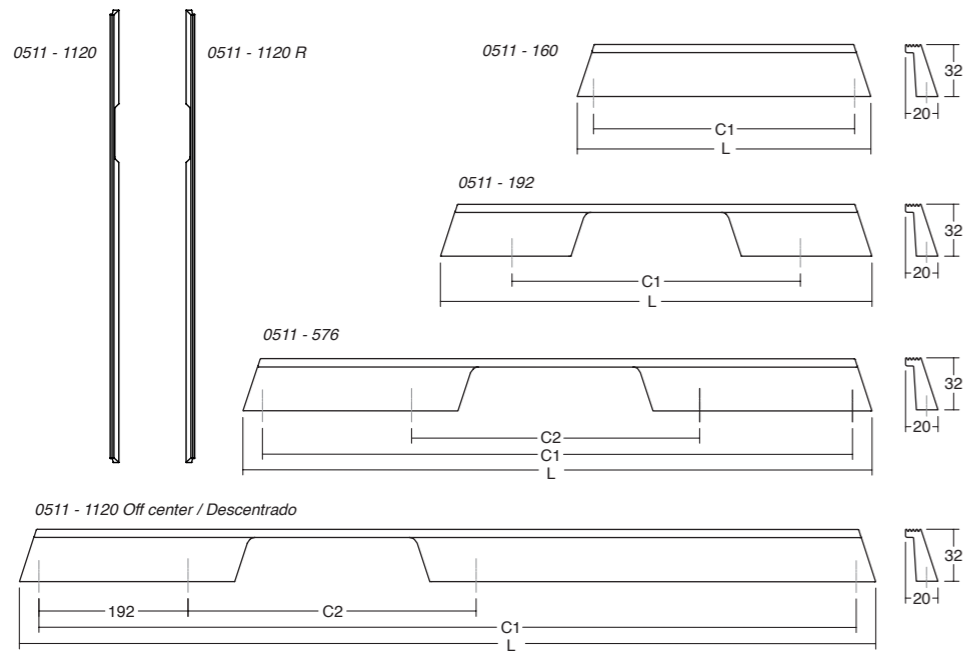

L24	L30	L618	C1	C2	L	↓	☐
Stainless steel look Inox look	Brushed black Negro cepillado	Brushed brass cava Latón cava cepillado					
0511160L24	0511160L30	0511160L618	160	-	180	2	25
0511192L24	0511192L30	0511192L618	192	-	280	2	25
0511576L24	0511576L30	0511576L618	576	192	600	4	15
05111120L24*	05111120L30*	05111120L618*	1120	192	1150	4	15 Off-center / Descentrado
05111120L24R*	05111120L30R*	05111120L618R*	1120	192	1150	4	15 Off-center / Descentrado

\* The two 1150mm are symmetrical and one is left and the other right / Los dos de 1150mm son simétricos y uno es izquierda y el otro derecha

0507 **OBLONG** LEATHER / ZAMAK Designer: Frank Person

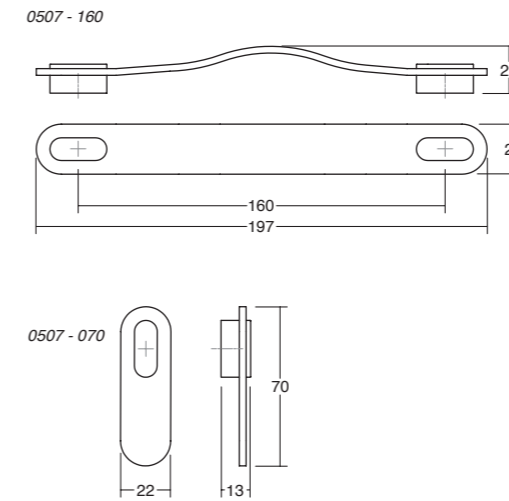

	P26 Beige / Beige	P36 Brown / Marrón	P99 Black / Negro	↓	☐
Z01 Polished chrome/ Cromo brillo	0507070P2601	0507070P3601	0507070P9901	1	25
Z01 Polished chrome/ Cromo brillo	0507160P2601	0507160P3601	0507160P9901	2	25
Z28 Brushed gold / Oro cepillado	0507070P2628	0507070P3628	0507070P9928	1	25
Z28 Brushed gold / Oro cepillado	0507160P2628	0507160P3628	0507160P9928	2	25
Z31 Brushed grey / Gris cepillado	0507070P2631	0507070P3631	0507070P9931	1	25
Z31 Brushed grey / Gris cepillado	0507160P2631	0507160P3631	0507160P9931	2	25
ZM1 Matt white / Blanco mate	0507070P26M1	-	-	1	25
ZM1 Matt white / Blanco mate	0507160P26M1	-	-	2	25
ZM2 Matt black / Negro mate	0507070P26M2	0507070P36M2	0507070P99M2	1	25
ZM2 Matt black / Negro mate	0507160P26M2	0507160P36M2	0507160P99M2	2	25

0056 **U** ZAMAK Designer: Viefe Studio

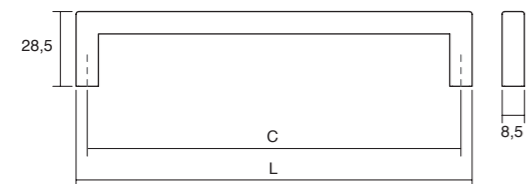

Z01	Z11	Z23	Z26	Z27	Z31	ZM1	ZM2	C	L	↓	☐
Polished chrome Cromo brillo	Matt chrome Cromo mate	Brushed nickel Níquel cepillado	Brushed copper Cobre cepillado	Brushed brass Latón cepillado	Brushed grey Gris cepillado	Matt white Blanco mate	Matt black Negro mate				
0056128Z01	0056128Z11	0056128Z23	0056128Z26	0056128Z27	0056128Z31	0056128ZM1	0056128ZM2	128	136,5	2	25
0056160Z01	0056160Z11	0056160Z23	0056160Z26	0056160Z27	0056160Z31	0056160ZM1	0056160ZM2	160	168,5	2	25
0056192Z01	0056192Z11	0056192Z23	0056192Z26	0056192Z27	0056192Z31	0056192ZM1	0056192ZM2	192	200,5	2	25
0056320Z01	0056320Z11	0056320Z23	0056320Z26	0056320Z27	0056320Z31	0056320ZM1	0056320ZM2	320	328,5	2	25
0056492Z01	0056492Z11	0056492Z23	0056492Z26	0056492Z27	0056492Z31	0056492ZM1	0056492ZM2	492	500,5	2	25

0241 **ROMA** ZAMAK Designer: 2J Design

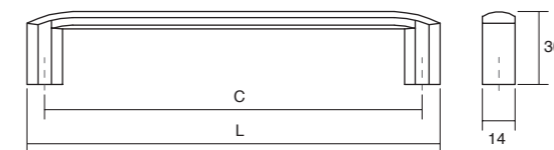

Z01	Z23	Z28	ZM2	C	L	↓	☐
Polished chrome Cromo brillo	Brushed nickel Níquel cepillado	Brushed gold Oro cepillado	Matt black Negro mate				
0241160Z01	0241160Z23	0241160Z28	0241160ZM2	160	175	2	25
0241192Z01	0241192Z23	0241192Z28	0241192ZM2	192	207	2	25
0241320Z01	0241320Z23	0241320Z28	0241320ZM2	320	335	2	25

0494 **LAND** ZAMAK Designer: Héctor Diego

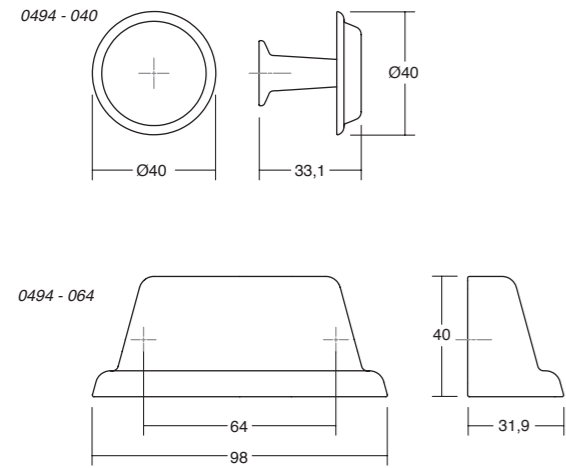

Z28	Z610	Z614	ZM2	↓	📦
Brushed gold Oro cepillado	Pewter Peltre	Antique brass Latón antiguo	Matt black Negro mate		
0494040Z28	0494040Z610	0494040Z614	0494040ZM2	1	25
0494064Z28	0494064Z610	0494064Z614	0494064ZM2	2	25



0506 **FIRM** ZAMAK Designer: Frank Person

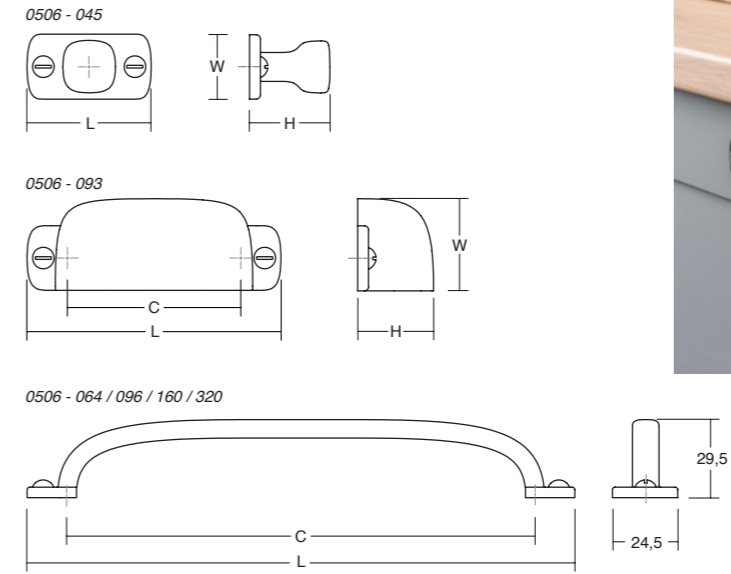

ZM22	C	L	W	H	↓	📦
Textured black Negro texturizado						
0506045ZM22	-	45,8	24	29,9	1	25
0506064ZM22	64	93,8	24,5	29,5	2	25
0506093ZM22	64	93,8	34	28	2	25
0506096ZM22	96	125,8	24,5	29,5	2	25
0506160ZM22	160	189,8	24,5	29,6	2	25
0506320ZM22	320	349,8	24,5	29,6	2	25



0446 **ESTE** ZAMAK Designer: Balutto Associati

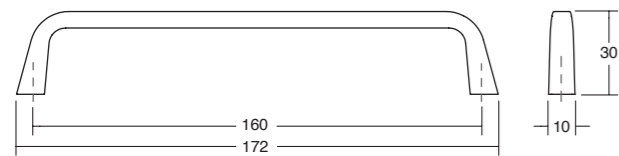

Z01	Z11	Z23	Z26	Z28	Z617	ZM2	↓	📦
Polished chrome Cromo brillo	Matt chrome Cromo mate	Brushed nickel Níquel cepillado	Brushed copper Cobre cepillado	Brushed gold Oro cepillado	Graphite grey Gris grafito	Matt black Negro mate		
0446160Z01	0446160Z11	0446160Z23	0446160Z26	0446160Z28	0446160Z617	0446160ZM2	2	25



0459 **LINES** ZAMAK Designer: Teruel & Paré

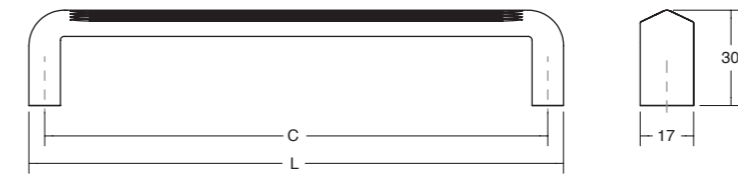

Z23	Z28	Z32	ZM2	C	L	↓	📦
Brushed Níquel Níquel cepillado	Brushed gold Oro cepillado	Brushed mole grey Gris topo cepillado	Matt black Negro mate				
0459160Z23	0459160Z28	0459160Z32	0459160ZM2	160	170	2	25
0459320Z23	0459320Z28	0459320Z32	0459320ZM2	320	330	2	25

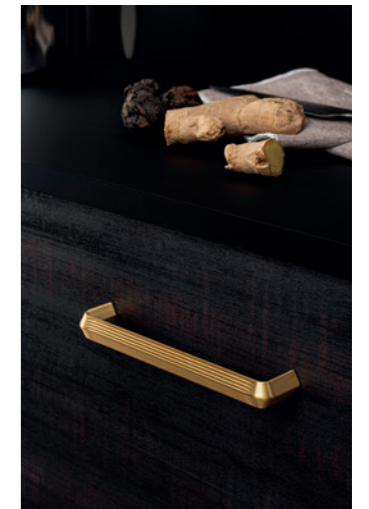

0516 **PENDANT** ZAMAK Designer: Frank Person

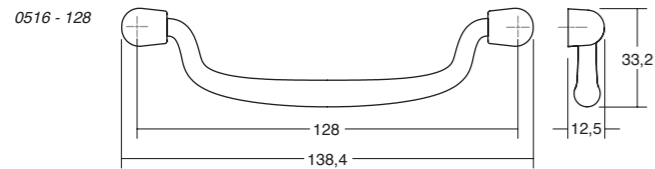
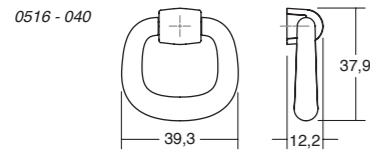

Z610	Z614	ZM2	↓	☐
Pewter	Antique brass	Matt black		
Peltre	Latón antiguo	Negro mate		
0516040Z610	0516040Z614	0516040ZM2	1	25
0516128Z610	0516128Z614	0516128ZM2	2	25



0486 **GRAF BIG** ALUMINIUM Designer: Viefe Studio

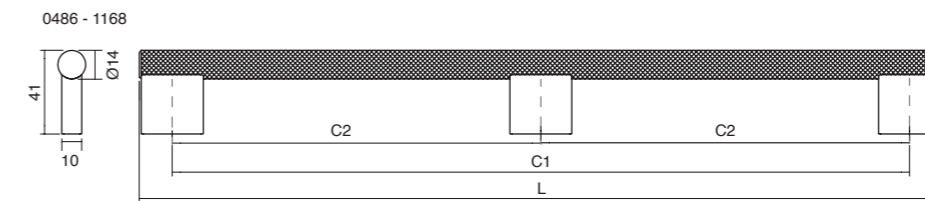
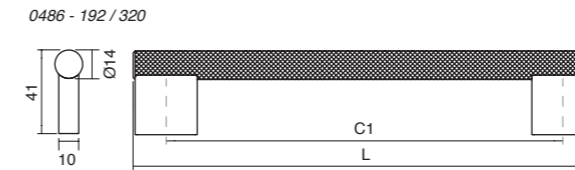
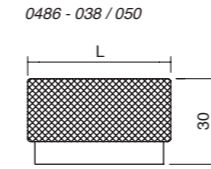

L24	L291	L30	C1	C2	L	↓	☐
Stainless steel look	Brushed brass	Brushed black					
Inox look	Latón cepillado	Negro cepillado					
0486038L24	0486038L291	0486038L30	-	-	Ø38	1	25
0486050L24	0486050L291	0486050L30	-	-	Ø50	1	25
0486192L24	0486192L291	0486192L30	192	-	224	2	25
0486320L24	0486320L291	0486320L30	320	-	352	2	25
04861168L24	04861168L291	04861168L30	1168	584	1200	3	10



0094 **HIDE** ZAMAK Designer: Viefe Studio

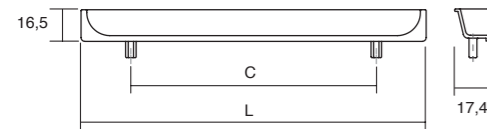

Z01	Z23	Z28	ZP1	ZM1	ZM2	C	L	↓	☐
Polished chrome	Brushed nickel	Brushed gold	Chrome look	Matt white	Matt black				
Cromo brillo	Níquel cepillado	Oro cepillado	Cromo look	Blanco mate	Negro mate				
0094090Z01	0094090Z23	0094090Z28	-	0094090ZM1	0094090ZM2	64	90	2	25
0094180Z01	0094180Z23	0094180Z28	-	0094180ZM1	0094180ZM2	128	180	2	25
-	-	-	0094200ZP1	-	-	128	200	2	25

0430 **GRAF MINI** ALUMINIUM Designer: Viefe Studio

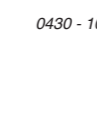
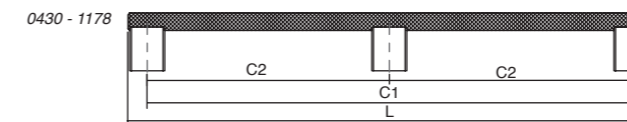
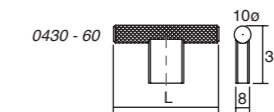
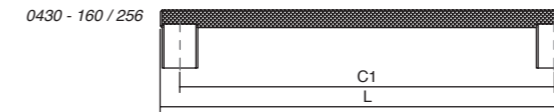

Includes non-twisting tip  
Incluye punta anti-giro

L24	L291	L30	C1	C2	L	↓	☐
Stainless steel look	Brushed brass	Brushed black					
Inox look	Latón cepillado	Negro cepillado					
0430010L24	0430010L291	0430010L30	-	-	10	1	25
0430060L24	0430060L291	0430060L30	-	-	60	1	25
0430160L24	0430160L291	0430160L30	160	-	182	2	25
0430256L24	0430256L291	0430256L30	256	-	278	2	25
04301178L24	04301178L291	04301178L30	1178	589	1200	3	10



0109 **GRAF** ALUMINIUM Designer: Viefe Studio

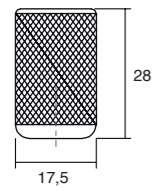

L01	L04	L24	L27	L291	LM2	
Polished chrome	Anodized matt	Stain. steel look	Brushed brass	Brushed brass	Matt black	↓
Cromo brillo	Anodizado mate	Inox look	Latón cepillado	Latón cepillado	Negro mate	↓
0109017L01	0109017L04	0109017L24	0109017L27	0109017L291	0109017LM2	1 25

0447 **BELLA** ZAMAK Designer: Balutto Associati

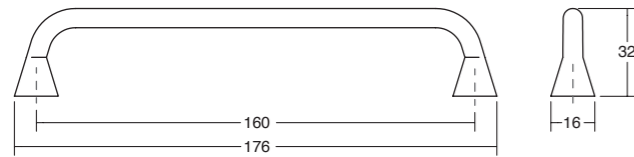

Z26	Z28	Z617	ZM2	
Brushed copper	Brushed gold	Graphite grey	Matt black	↓
Cobre cepillado	Oro cepillado	Gris grafito	Negro mate	↓
0447160Z26	0447160Z28	0447160Z617	0447160ZM2	2 25

0451 **FELTRE** ZAMAK Designer: Balutto Associati

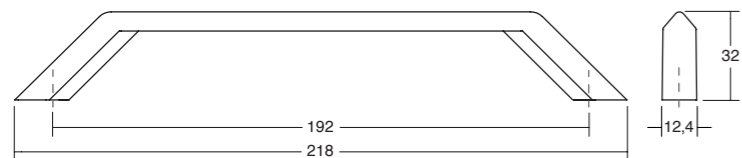

Z23	Z617	ZM2	
Brushed nickel	Graphite grey	Matt black	↓
Níquel cepillado	Gris grafito	Negro mate	↓
0451192Z23	0451192Z617	0451192ZM2	2 25

0449 **HEXXA** ALUMINIUM/ZAMAK Designer: Alexis Vivet

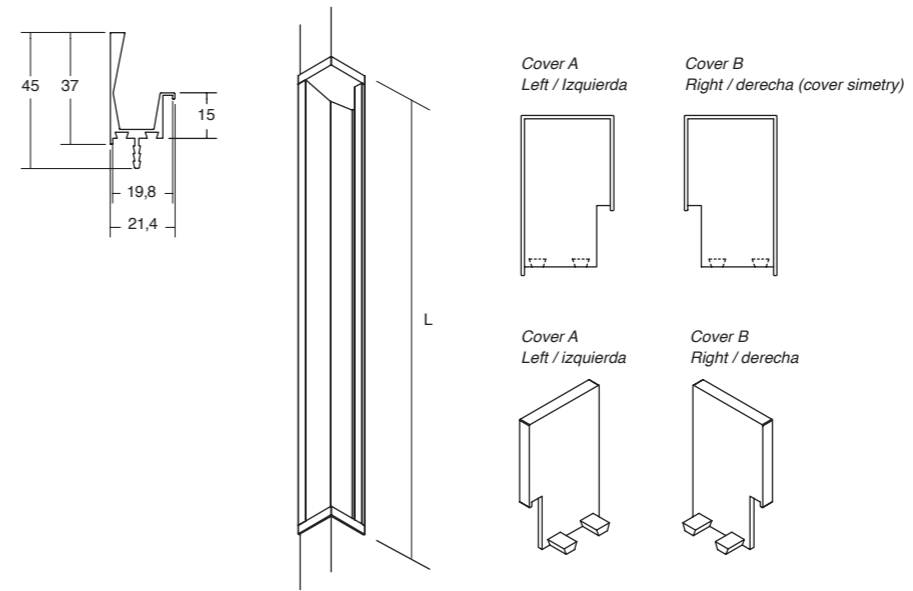

LM1	LM2	LM23	LM41	L	
Matt white	Matt black	Metallic grey	Metallic brown		↓
Blanco mate	Negro mate	Gris metal	Marrón metal		↓
0449200LM1	0449200LM2	0449200LM23	0449200LM41	200	25 ALUMINIUM
0449350LM1	0449350LM2	0449350LM23	0449350LM41	350	25 ALUMINIUM
04491100LM1	04491100LM2	04491100LM23	04491100LM41	1100	15 ALUMINIUM
04493000LM1	04493000LM2	04493000LM23	04493000LM41	3000	10* ALUMINIUM
0449035ZM1A	0449035ZM2A	0449035ZM23A	0449035ZM41A	-	25 ZAMAK
0449035ZM1B	0449035ZM2B	0449035ZM23B	0449035ZM41B	-	25 ZAMAK

\* Three metre profiles are delivered according to the units of the original packaging and cannot be sold separately.  
Las barras de tres metros se sirven según las cantidades del embalaje original y no se pueden servir por separado.



0119 **WAVE** ZAMAK Designer: Viefe Studio

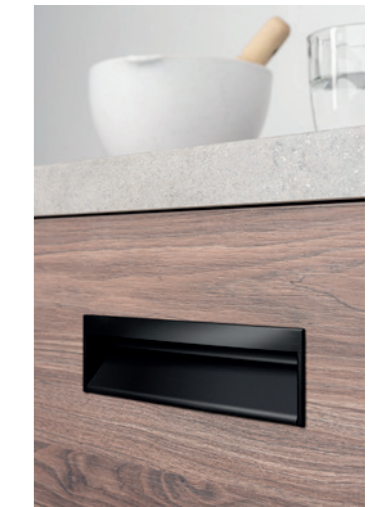
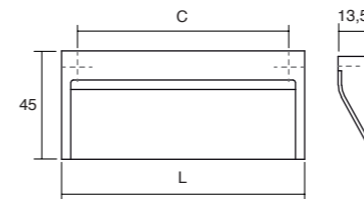

Z01	Z23	ZM2	C	L	
Polished chrome	Brushed nickel	Matt black			↓
Cromo brillo	Níquel cepillado	Negro mate			↓
0119032Z01	0119032Z23	0119032ZM2	32	45	2 25
0119160Z01	0119160Z23	0119160ZM2	160	173	2 25



# 0105 NEST

ZAMAK

Designer: Viefe Studio

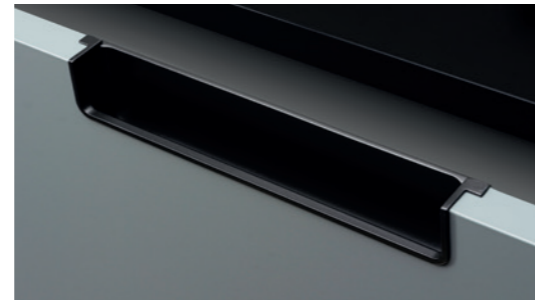
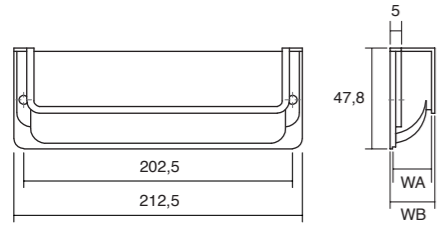

Z01	Z01M1	Z23	Z23M1	ZM2	WA	WB	↓	☐	Door
Polished chrome <i>Cromo brillo</i>	Polished chrome+White <i>Cromo brillo+ Blanco</i>	Brushed nickel <i>Níquel cepillado</i>	Brushed nickel+White <i>Níquel cepillado+Blanco</i>	Matt black <i>Negro mate</i>					<i>Puerta</i>
0105186Z01ST	0105186Z01M1	0105186Z23ST	0105186Z23M1	0105186ZM2ST	18,6	21,3	2	25	19
-	-	0105206Z23ST	-	-	20,6	23,3	2	25	20,5

# 0073 TAP

ZAMAK

Designer: Viefe Studio

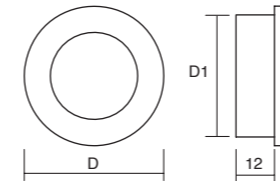

ZP1	ZM2	D	D1	☐
Chrome look <i>Cromo look</i>	Matt black <i>Negro mate</i>			
0073040ZP1	0073040ZM2	40	35,5	25
0073060ZP1	0073060ZM2	60	55,3	25

# 0235 CLOS

ZAMAK

Designer: Viefe Studio

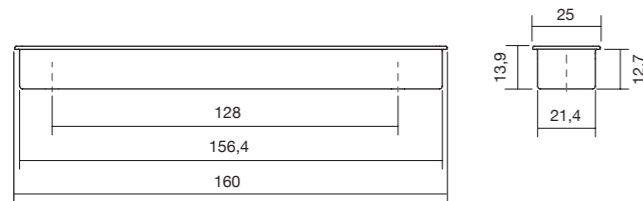

ZM1	ZM2	Z01	Z23	↓	☐
Matt white <i>Blanco mate</i>	Matt black <i>Negro mate</i>	Polished chrome <i>Cromo brillo</i>	Brushed nickel <i>Níquel cepillado</i>		
0235128ZM1	0235128ZM2	0235128Z01	0235128Z23	2	25

# 0301 SENSE MINI

ALUMINIUM

Designer: Viefe Studio

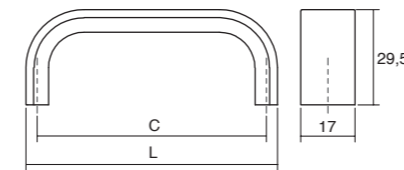

L01	L09	L24	L29	C	L	↓	☐
Polished chrome <i>Cromo brillo</i>	Matt black <i>Negro mate</i>	Stainless steel look <i>inox look</i>	Brushed dark brass <i>Latón oscuro cepillado</i>				
0301096L01	0301096L09	0301096L24	0301096L29	96	103	2	25
0301160L01	0301160L09	0301160L24	0301160L29	160	167	2	25
0301256L01	0301256L09	0301256L24	0301256L29	256	263	2	25

# 0366 CUBIC

ZAMAK

Designer: Viefe Studio

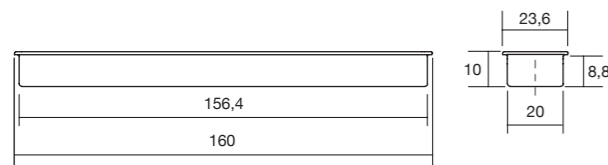

ZM1	ZM2	☐
Matt white <i>Blanco mate</i>	Matt black <i>Negro mate</i>	
0366160ZM1	0366160ZM2	25

# 0195 SENSE

ALUMINIUM

Designer: Viefe Studio

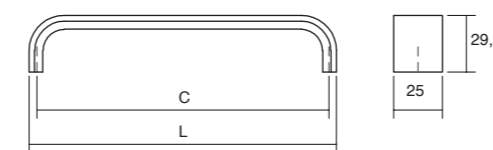

L01	L24	L30	C	L	↓	☐
Polished chrome <i>Cromo brillo</i>	Stainless steel look <i>Inox look</i>	Brushed black <i>Negro cepillado</i>				
0195128L01	0195128L24	0195128L30	128	135	2	25
0195192L01	0195192L24	0195192L30	192	199	2	25
0195320L01	0195320L24	0195320L30	320	327	2	25
0195480L01	0195480L24	0195480L30	480	487	2	25

0162 **KADO** ZAMAK Designer: Viefe Studio

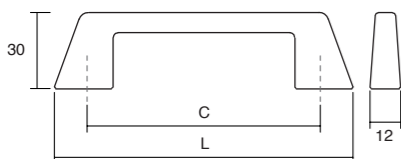

Z01	Z23	C	L	↓	☐
Polished chrome <i>Cromo brillo</i>	Brushed nickel <i>Níquel cepillado</i>				
0162160Z01	0162160Z23	160	186	2	25
0162320Z01	0162320Z23	320	346	2	25



0077 **ANGLE** ALUMINIUM Designer: Viefe Studio

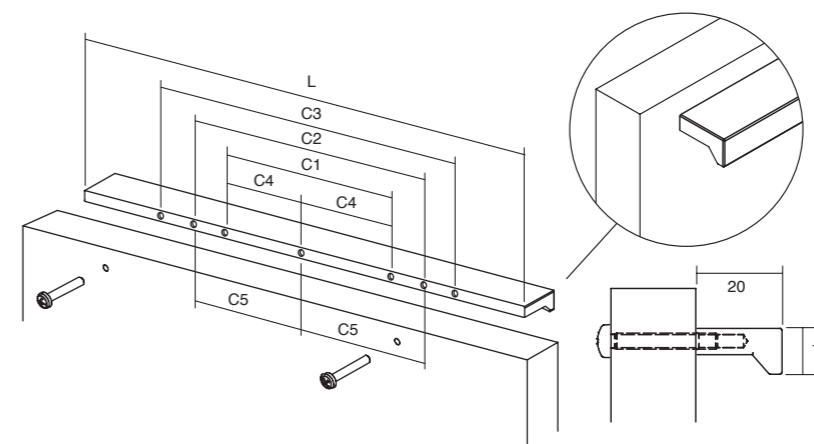

L01	L04	L24	L29	LM1	LM2	LM23	LM41	C1	C2	C3	C4	C5	L	↓	☐
Polish. chrome <i>Cromo brillo</i>	Anodized matt <i>Anodizado mate</i>	Stai. steel look <i>Inox look</i>	Brus. dark brass <i>Ltn osc. cepillado</i>	Matt White <i>Blanco mate</i>	Matt black <i>Negro mate</i>	Metallic grey <i>Gris metal</i>	Metallic brown <i>Marrón metal</i>								
-	0077032L04	-	-	-	-	-	-	32	-	-	-	-	45	2	25
-	0077064L04	-	-	-	-	-	-	64	-	-	-	-	90	2	25
0077064L01	-	0077064L24	0077064L29	0077064LM1	0077064LM2	0077064LM23	0077064LM41	64	-	-	-	-	100	2	25
-	-	-	-	0077128LM1	0077128LM2	0077128LM23	0077128LM41	128	160	-	-	-	200	4	25
-	0077096L04	-	-	-	-	-	-	96	-	-	-	-	120	2	25
-	0077128L04	-	-	-	-	-	-	128	-	-	-	-	150	2	25
0077128L01	-	0077128L24	0077128L29	-	-	-	-	96	128	160	-	-	200	6	25
-	0077160L04	-	-	-	-	-	-	160	-	-	-	-	190	2	25
-	0077192L04	-	-	-	-	-	-	192	-	-	-	-	250	2	25
0077192L01	-	0077192L24	0077192L29	0077192LM1	0077192LM2	0077192LM23	0077192LM41	192	-	-	-	-	300	2	25
-	-	-	-	0077256LM1	0077256LM2	0077256LM23	0077256LM41	256	-	-	-	-	400	2	25
-	0077256L04	-	-	-	-	-	-	256	-	-	-	-	300	2	25
0077256L01	-	0077256L24	0077256L29	-	-	-	-	256	320	-	-	-	400	4	25
-	-	-	-	0077416LM1	0077416LM2	0077416LM23	0077416LM41	416	-	-	-	-	500	2	25
0077416L01	-	0077416L24	0077416L29	-	-	-	-	320	416	-	-	-	500	4	25
-	-	-	-	0077480LM1	0077480LM2	0077480LM23	0077480LM41	480	-	-	-	-	600	2	25
0077512L01	-	0077512L24	0077512L29	-	-	-	-	480	512	-	-	256	600	5	25
0077640L01	-	0077640L24	0077640L29	0077640LM1	0077640LM2	0077640LM23	0077640LM41	640	-	-	320	-	900	3	25
-	-	-	-	00771440LM1	00771440LM2	00771440LM23	00771440LM41	480	1440	-	-	-	1480	4	10

0373 **NICK** ZAMAK Designer: Alexis Vivet

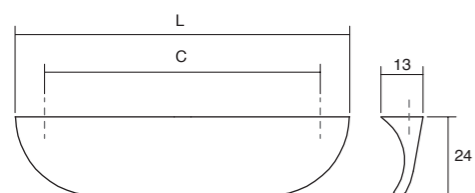

Z01	Z23	Z26	Z27	C	L	↓	☐
Polished chrome <i>Cromo brillo</i>	Brushed nickel <i>Níquel cepillado</i>	Brushed copper <i>Cobre cepillado</i>	Brushed brass <i>Latón cepillado</i>				
0373032Z01	0373032Z23	0373032Z26	0373032Z27	32	50	2	25
0373160Z01	0373160Z23	0373160Z26	0373160Z27	160	178	2	25



0206 **ARCH** ZAMAK Designer: 2J Design

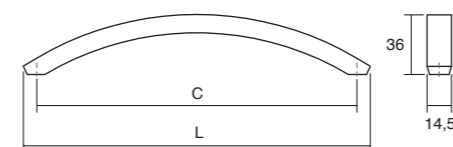

Z01	Z23	C	L	↓	☐
Polished chrome <i>Cromo brillo</i>	Brushed nickel <i>Níquel cepillado</i>				
0206192Z01	0206192Z23	192	208,5	2	25
0206320Z01	0206320Z23	320	338,5	2	25



0452 **BRAVE** ALUMINIUM Designer: Viefe Studio

LM1	LM2	LM23	LM41	C1	C2	L	↓	☐
Matt white Blanco mate	Matt black Negro mate	Metallic grey Gris metal	Metallic brown Marrón metal					
0452128FM1	0452128FM2	0452128FM23	0452128FM41	128	-	160	2	25
0452192FM1	0452192FM2	0452192FM23	0452192FM41	192	-	240	2	25
0452320FM1	0452320FM2	0452320FM23	0452320FM41	320	-	400	2	25
0452480FM1	0452480FM2	0452480FM23	0452480FM41	192	480	600	4	25
0452992FM1	0452992FM2	0452992FM23	0452992FM41	192	992	1040	4	15
04521120FM1	04521120FM2	04521120FM23	04521120FM41	192	1120	1150	4	15

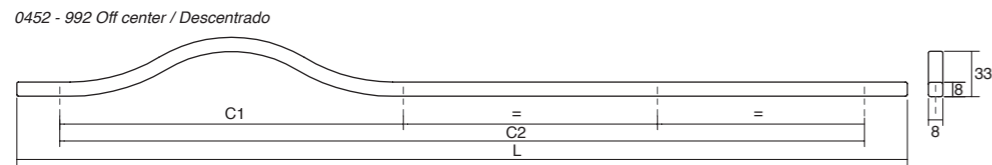
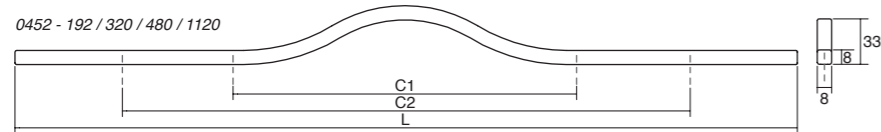
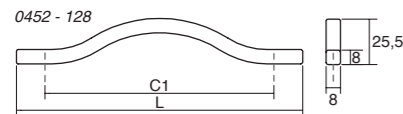

0444 **PEAK** ALUMINIUM Designer: Viefe Studio

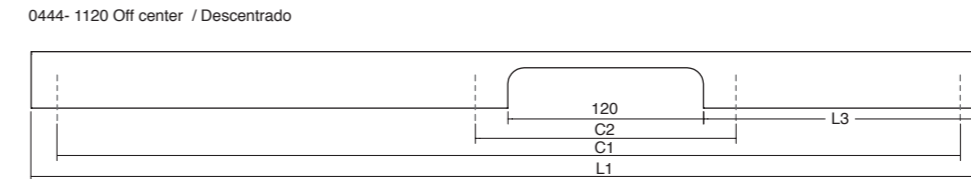
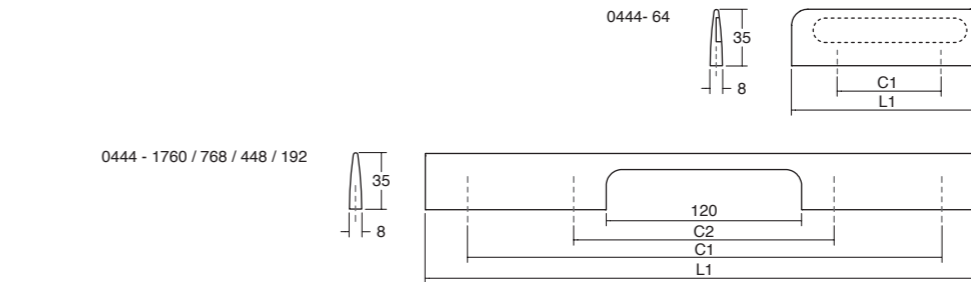

L24	L30	LM1	LM23	LM41	C1	C2	L1	L3	↓	☐
Stain. steel look Inox look	Brushed black Negro cepillado	Matt white Blanco mate	Metallic grey Gris metal	Metallic brown Marrón metal						
0444064L24	0444064L30	0444064LM1	0444064LM23	0444064LM41	64	-	120	-	2	25
0444192L24	0444192L30	0444192LM1	0444192LM23	0444192LM41	192	160	250	-	4	25
0444448L24	0444448L30	0444448LM1	0444448LM23	0444448LM41	448	160	500	-	4	25
0444768L24	0444768L30	0444768LM1	0444768LM23	0444768LM41	768	160	800	-	4	15
04441120L24	04441120L30	04441120LM1	04441120LM23	04441120LM41	1120	160	1150	190	4	15
04441760L24	04441760L30	04441760LM1	04441760LM23	04441760LM41	1760	160	1800	-	4	10



0322 **CUTT** ALUMINIUM Designer: Alexis Vivet

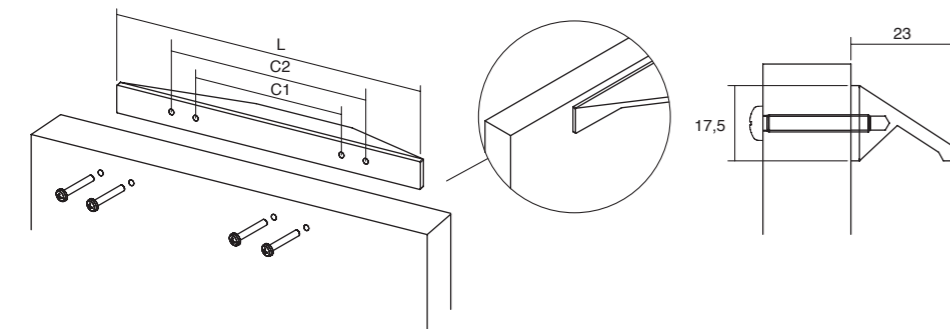

L01	L09	L24	C1	C2	L	↓	☐
Polished chrome Cromo brillo	Matt black Negro mate	Stainless steel look Inox look					
0322200L01	0322200L09	0322200L24	96	128	200	4	25
0322400L01	0322400L09	0322400L24	192	320	400	4	25
0322600L01	0322600L09	0322600L24	320	480	600	4	25
-	03221000L09	03221000L24	320	896	1000	4	15
-	03221500L09	03221500L24	480	1376	1500	4	10



0375 **VANN** ALUMINIUM Designer: Alexis Vivet

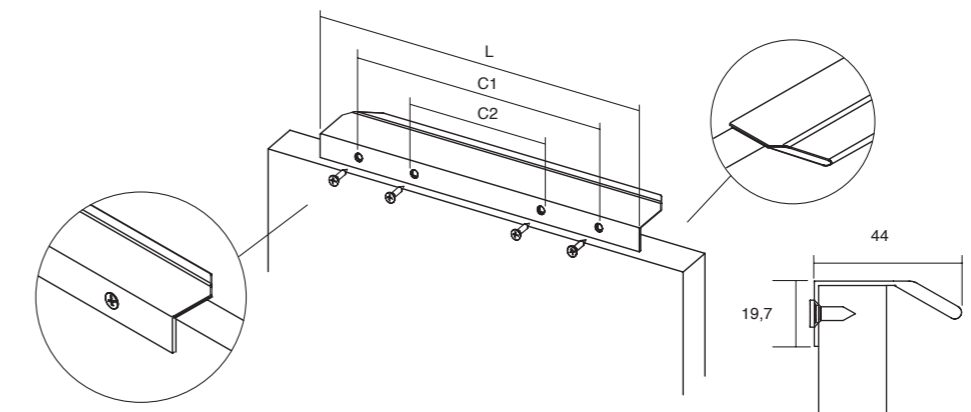

L02	L04	L09	L24	L29	C1	C2	L	↓	☐
Anodized bright Anodizado brillo	Anodized matt Anodizado mate	Matt black Negro mate	Stain steel look Inox look	Brushed dark brass Latón oscuro cepill.					
0375064L02	0375064L04	0375064L09	0375064L24	0375064L29	64	-	100	2	25
0375128L02	0375128L04	0375128L09	0375128L24	0375128L29	128	-	200	2	25
0375256L02	0375256L04	0375256L09	0375256L24	0375256L29	256	-	350	2	25
-	03751120L04	03751120L09	03751120L24	03751120L29	1120	384	1200	4	15



0372 **ONA** ALUMINIUM Designer: Teruel Paré

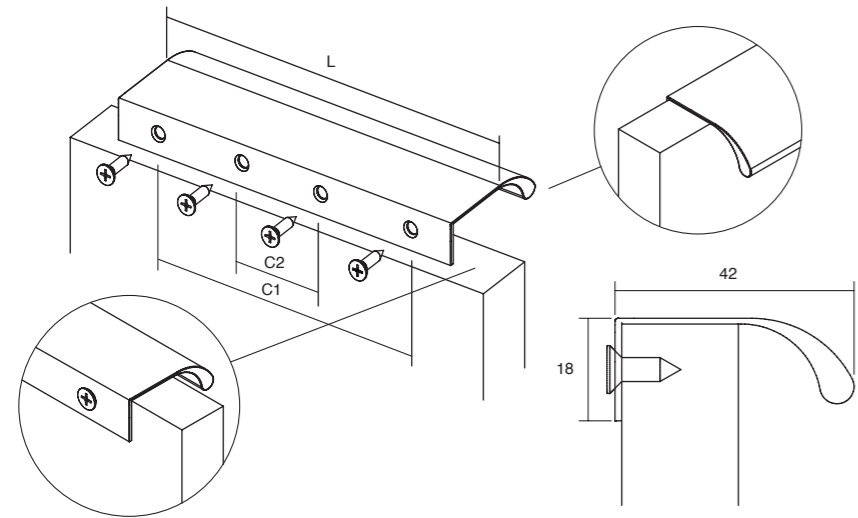

L24	L29	L30	L31	LM1	LM23	LM41	C1	C2	L	↓	☐
Stainless steel look Inox look	Brushed dark brass Latón cepillado oscuro	Brushed black Negro cepillado	Brushed grey Gris cepillado	Matt white Blanco mate	Metallic grey Gris metal	Metallic brown Marrón metal					
0372032L24	0372032L29	0372032L30	0372032L31	0372032LM1	0372032LM23	0372032LM41	32	-	50	2	25
0372128L24	0372128L29	0372128L30	0372128L31	0372128LM1	0372128LM23	0372128LM41	128	-	200	2	25
0372256L24	0372256L29	0372256L30	0372256L31	0372256LM1	0372256LM23	0372256LM41	256	-	350	2	25
0372544L24	0372544L29	0372544L30	0372544L31	0372544LM1	0372544LM23	0372544LM41	544	-	600	3	25
03721056L24	03721056L29	03721056L30	03721056L31	03721056LM1	03721056LM23	03721056LM41	1056	416	1100	4	15
03721440L24	03721440L29	03721440L30	03721440L31	03721440LM1	03721440LM23	03721440LM41	1440	480	1500	4	10

0053 **DINO** ZAMAK Designer: Viefte Studio

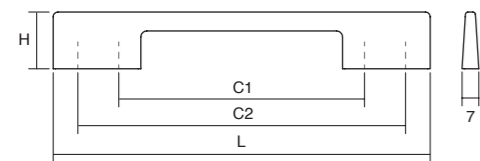

Z01	Z23	ZM1	ZM2	ZP4	C1	C2	L	H	↓	☐
Polished chrome Cromo brillo	Brushed nickel Níquel cepillado	Matt white Blanco mate	Matt black Negro mate	Aluminium look Aluminio look						
0053096Z01	0053096Z23	0053096ZM1	0053096ZM2	0053096ZP4	96	128	156	24	4	25
0053192Z01	0053192Z23	0053192ZM1	0053192ZM2	0053192ZP4	160	192	221	28	4	25
0053320Z01	0053320Z23	0053320ZM1	0053320ZM2	0053320ZP4	288	320	349	28	4	25

0117 **CURVE** ALUMINIUM Designer: Viefte Studio

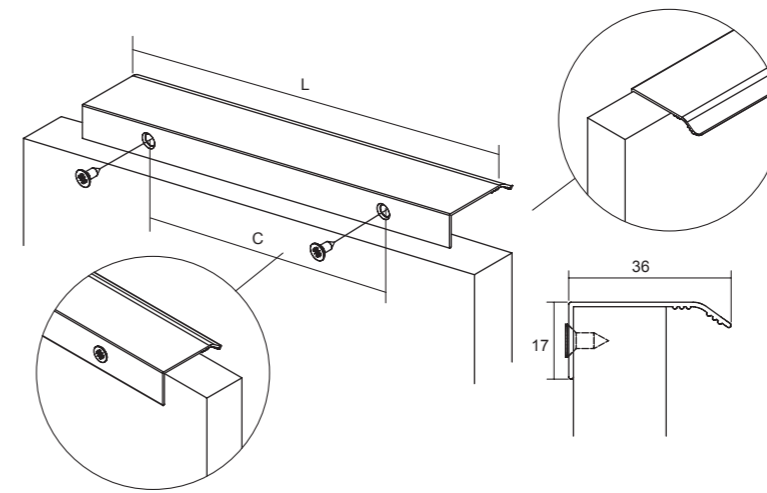

L04	L24	L31	LM1	LM2	C	L	↓	☐
Anodized matt Anodizado mate	Stainless steel look Inox look	Brushed grey Gris cepillado	Matt white Blanco mate	Matt black Negro mate				
0117032L04	0117032L24	0117032L31	0117032LM1	0117032LM2	32	45	2	25
-	0117064L24	-	-	-	64	100	2	25
0117128L04	0117128L24	0117128L31	0117128LM1	0117128LM2	128	200	2	25
-	0117192L24	-	-	-	192	300	2	25
-	0117320L24	-	-	-	320	400	3	25
-	0117416L24	-	-	-	416	500	3	25

0139 / 0140 **LINEAR** ALUMINIUM Designer: Viefte Studio

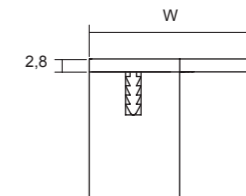
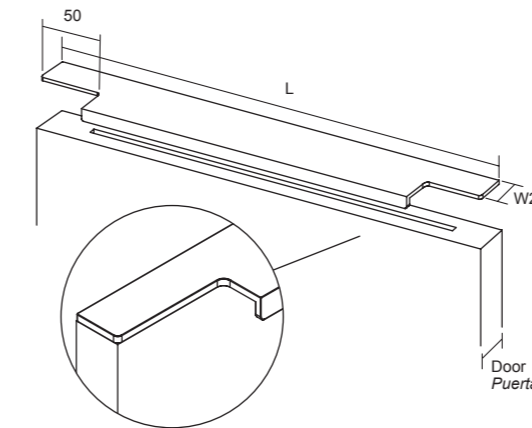

L24	L30	L	W (d19)	W2	Door Puerta	L24	L30	L	W (d20,5)	W2	Door Puerta
Stain. steel look Inox look	Brushed black Negro cepillado					Stain. steel look Inox look	Brushed black Negro cepillado				
0139147L24	0139147L30	147	37	19,8	15 19mm	0140147L24	0140147L30	147	38,5	21	15 20,5mm
0139197L24	0139197L30	197	37	19,8	15 19mm	0140197L24	0140197L30	197	38,5	21	15 20,5mm
0139247L24	0139247L30	247	37	19,8	15 19mm	0140247L24	0140247L30	247	38,5	21	15 20,5mm
0139297L24	0139297L30	297	37	19,8	15 19mm	0140297L24	0140297L30	297	38,5	21	15 20,5mm
0139347L24	0139347L30	347	37	19,8	15 19mm	0140347L24	0140347L30	347	38,5	21	15 20,5mm
0139397L24	0139397L30	397	37	19,8	15 19mm	0140397L24	0140397L30	397	38,5	21	15 20,5mm
0139447L24	0139447L30	447	37	19,8	10 19mm	0140447L24	0140447L30	447	38,5	21	10 20,5mm
0139497L24	0139497L30	497	37	19,8	10 19mm	0140497L24	0140497L30	497	38,5	21	10 20,5mm
0139597L24	0139597L30	597	37	19,8	10 19mm	0140597L24	0140597L30	597	38,5	21	10 20,5mm
0139697L24	0139697L30	697	37	19,8	10 19mm	0140697L24	0140697L30	697	38,5	21	10 20,5mm
0139797L24	0139797L30	797	37	19,8	10 19mm	0140797L24	0140797L30	797	38,5	21	10 20,5mm
0139897L24	0139897L30	897	37	19,8	5 19mm	0140897L24	0140897L30	897	38,5	21	5 20,5mm
0139997L24	0139997L30	997	37	19,8	5 19mm	0140997L24	0140997L30	997	38,5	21	5 20,5mm
01391197L24	01391197L30	1197	37	19,8	5 19mm	01401197L24	01401197L30	1197	38,5	21	5 20,5mm

0434

**VECTOR**

ALUMINIUM

Designer: Viefe Studio

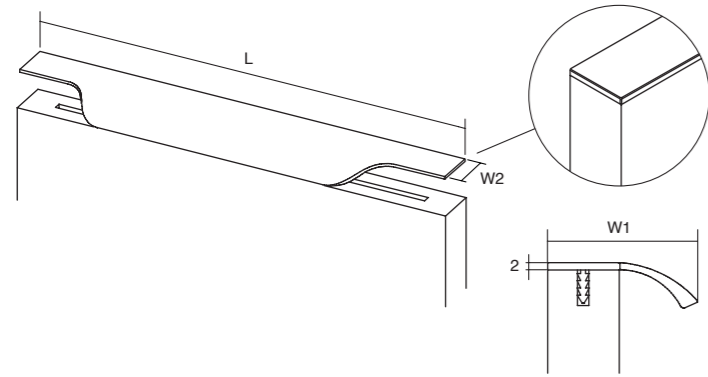

L24	L30	L31	L	W1	W2	Door
S. steel look Inox look	Brushed black Negro cepillado	Brushed grey Gris cepillado				Puerta
0434147L24	0434147L30	0434147L31	147	41	19.8	19
0434197L24	0434197L30	0434197L31	197	41	19.8	19
0434247L24	0434247L30	0434247L31	247	41	19.8	19
0434297L24	0434297L30	0434297L31	297	41	19.8	19
0434347L24	0434347L30	0434347L31	347	41	19.8	19
0434397L24	0434397L30	0434397L31	397	41	19.8	19
0434447L24	0434447L30	0434447L31	447	41	19.8	19
0434497L24	0434497L30	0434497L31	497	41	19.8	19
0434597L24	0434597L30	0434597L31	597	41	19.8	19
0434697L24	0434697L30	0434697L31	697	41	19.8	19
0434797L24	0434797L30	0434797L31	797	41	19.8	19
0434897L24	0434897L30	0434897L31	897	41	19.8	19
0434997L24	0434997L30	0434997L31	997	41	19.8	19
04341197L24	04341197L30	04341197L31	1197	41	19.8	19

0250 / 0251

**FORMA**

ALUMINIUM

Designer: 2J Design

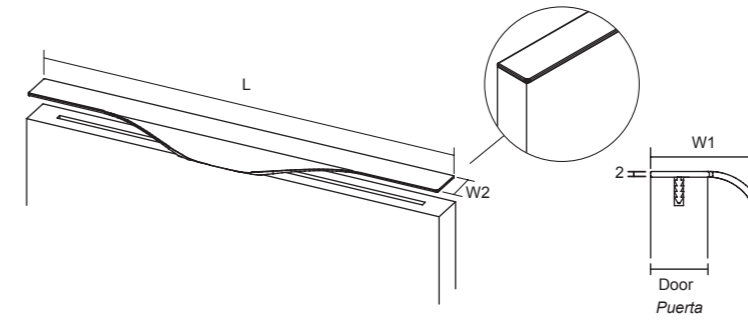

L24	L	W1	W2	Door	L24	L	W1	W2	Door	
Stain. steel look Inox look				Puerta	Stain. steel look Inox look				Puerta	
0250147L24	147	38	19,8	19	0251147L24	147	40	21	15	20,5
0250197L24	197	38	19,8	19	0251197L24	197	40	21	15	20,5
0250247L24	247	38	19,8	19	0251247L24	247	40	21	15	20,5
0250297L24	297	38	19,8	19	0251297L24	297	40	21	15	20,5
0250347L24	347	38	19,8	19	0251347L24	347	40	21	15	20,5
0250397L24	397	38	19,8	19	0251397L24	397	40	21	15	20,5
0250447L24	447	38	19,8	19	0251447L24	447	40	21	10	20,5
0250497L24	497	38	19,8	19	0251497L24	497	40	21	10	20,5
0250597L24	597	38	19,8	19	0251597L24	597	40	21	10	20,5
0250697L24	697	38	19,8	19	0251697L24	697	40	21	10	20,5
0250797L24	797	38	19,8	19	0251797L24	797	40	21	10	20,5
0250897L24	897	38	19,8	5	0251897L24	897	40	21	5	20,5
0250997L24	997	38	19,8	5	0251997L24	997	40	21	5	20,5
02501197L24	1197	38	19,8	5	02511197L24	1197	40	21	5	20,5

0254/0255

**NOMA**

ALUMINIUM

Designer: 2J Design

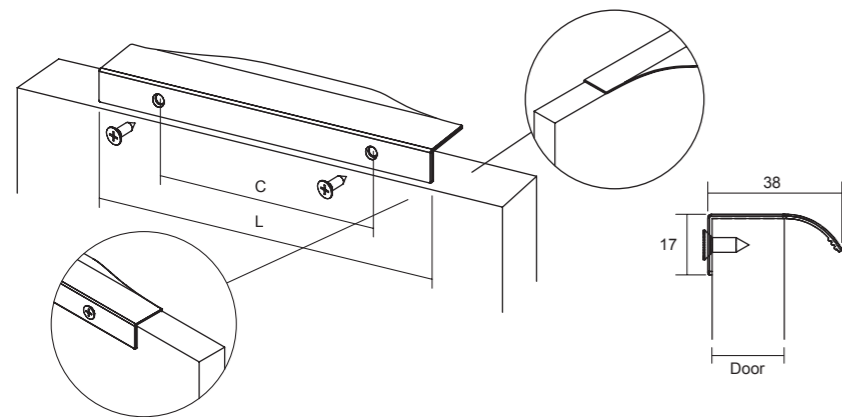

L02	L24	L30	L613	L618	C	L	↓	Door	
Anodized bright Anodizado brillo	Stainless steel look Inox look	Brushed black Negro cepillado	Antique bronze Bronce antiguo	Brushed brass cava Latón cava cepillado				Puerta	
0254128L02	0254128L24	0254128L30	0254128L613	0254128L618	128	200	2	25	19
0254256L02	0254256L24	0254256L30	0254256L613	0254256L618	256	350	2	25	19
-	0255128L24	-	-	-	128	200	2	25	22
-	0255256L24	-	-	-	256	350	2	25	22

0334

**BRIKK**

ALUMINIUM

Designer: Alexis Vivet

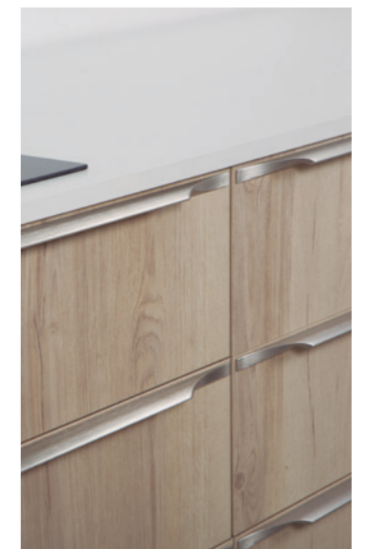
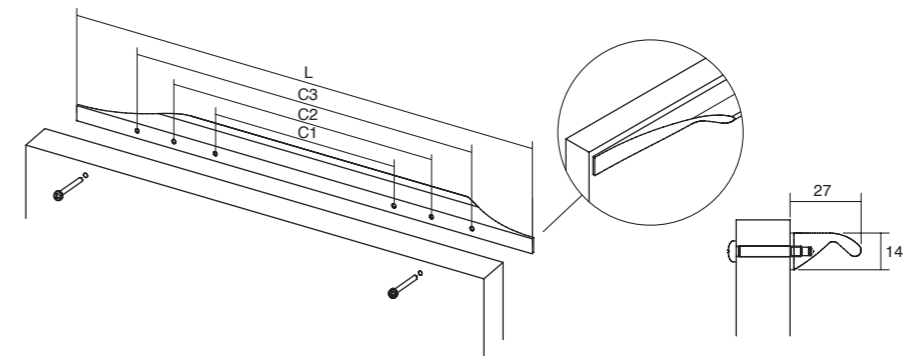

L24	L613	C1	C2	C3	L	↓	Door
Stainless steel look Inox look	Antique bronze Bronce antiguo						Puerta
0334140L24	0334140L613	32	-	-	140	2	15
0334190L24	-	64	-	-	190	2	15
0334240L24	-	96	-	-	240	2	15
0334290L24	0334290L613	160	-	-	290	2	15
0334340L24	-	192	-	-	340	2	15
0334390L24	-	128	260	-	390	4	15
0334440L24	-	160	310	-	440	4	10
0334490L24	0334490L613	192	360	-	490	4	10
0334590L24	-	224	460	-	590	4	10
0334690L24	-	256	560	-	690	4	10
0334790L24	-	320	660	-	790	4	10
0334890L24	-	384	760	-	890	4	5
0334990L24	-	320	640	860	990	6	5
03341190L24	03341190L613	320	832	1060	1190	6	5

0380 **STEEP** ALUMINIUM Designer: Viefe Studio

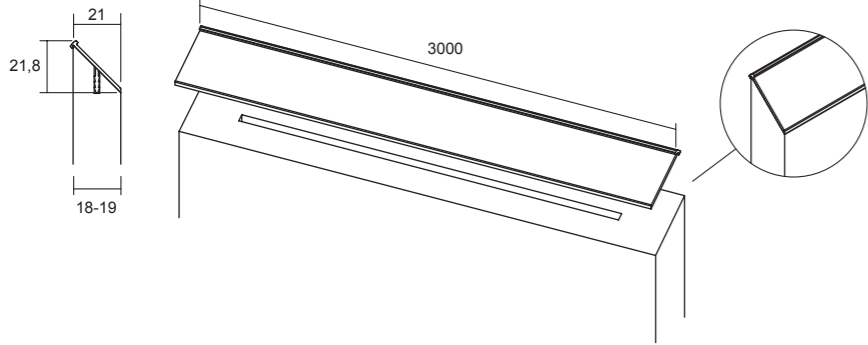

L02	L24	LM2	
Anodized bright Anodizado brillo	Stainless steel look Inox look	Matt black Negro mate	📦
03803000L02	03803000L24	03803000LM2	15 *

\* Three metre profiles are delivered according to the units of the original packaging and cannot be sold separately.  
Las barras de tres metros se sirven según las cantidades del embalaje original y no se pueden servir por separado.

0219 **ARROW** ZAMAK Designer: 2J Design

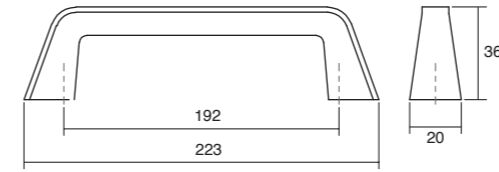

Z23	
Brushed nickel Níquel cepillado	📦
0219192Z23	2 25

0343 **GRADA** ALUMINIUM Designer: Viefe Studio

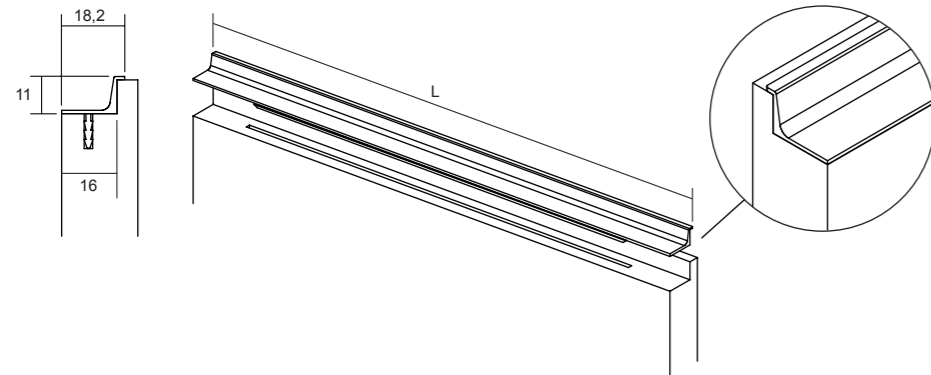

L02	L04	L24	LM1	LM2	L	
Anodized bright Anodizado brillo	Anodized matt Anodizado mate	Stainless steel look Inox look	Matt white Blanco mate	Matt black Negro mate		📦
-	0343147L04	0343147L24	0343147LM1	0343147LM2	147	15
-	0343197L04	0343197L24	0343197LM1	0343197LM2	197	15
-	0343247L04	0343247L24	0343247LM1	0343247LM2	247	15
-	0343297L04	0343297L24	0343297LM1	0343297LM2	297	15
-	0343347L04	0343347L24	0343347LM1	0343347LM2	347	15
-	0343397L04	0343397L24	0343397LM1	0343397LM2	397	15
-	0343447L04	0343447L24	0343447LM1	0343447LM2	447	10
-	0343497L04	0343497L24	0343497LM1	0343497LM2	497	10
-	0343597L04	0343597L24	0343597LM1	0343597LM2	597	10
-	0343697L04	0343697L24	0343697LM1	0343697LM2	697	10
-	0343797L04	0343797L24	0343797LM1	0343797LM2	797	10
-	0343897L04	0343897L24	0343897LM1	0343897LM2	897	5
-	0343997L04	0343997L24	0343997LM1	0343997LM2	997	5
-	03431197L04	03431197L24	03431197LM1	03431197LM2	1197	5
03433000L02	03433000L04	03433000L24	03433000LM1	03433000LM2	3000	15*

\* Three metre profiles are delivered according to the units of the original packaging and cannot be sold separately.  
Las barras de tres metros se sirven según las cantidades del embalaje original y no se pueden servir por separado.

0410 **BUTTON** ZAMAK Designer: Alexis Vivet

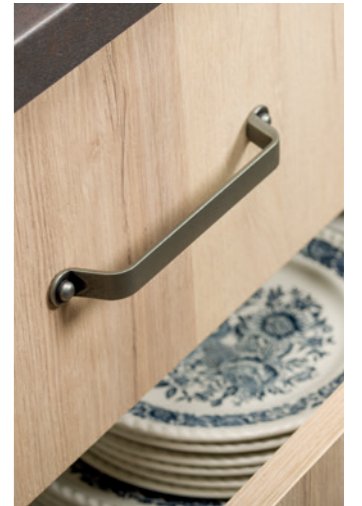
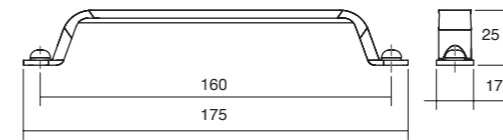

Z610	Z614	ZM2	
Pewter Peltre	Antique Brass Latón antiguo	Matt black Negro mate	📦
0410160Z610	0410160Z614	0410160ZM2	2 25

0393 **DUKE** ZAMAK Designer: Viefe Studio

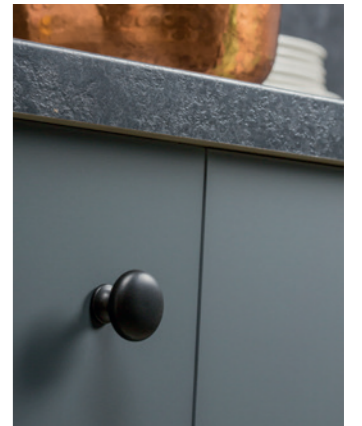
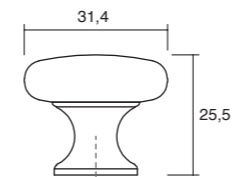

Z01	Z23	Z26	Z27	Z66	Z610	Z612	Z614	ZM1	ZM2	
Pol. chrome Cromo brillo	Brushed nickel Níquel cepill.	Brushed copper Cobre cepillado	Brushed brass Latón cepillado	Antique copper Cobre antiguo	Pewter Peltre	Antique silver Plata antigua	Antique Brass Latón antiguo	Matt white Blanco mate	Matt black Negro mate	📦
0393031Z01	0393031Z23	0393031Z26	0393031Z27	0393031Z66	0393031Z610	0393031Z612	0393031Z614	0393031ZM1	0393031ZM2	1 25

0226 **REDO** ZAMAK Designer: 2J Design

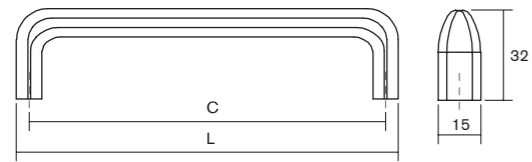

Z23	Z26	Z610	Z614	C	L	↓	☐
Brushed nickel	Brushed copper	Pewter	Antique Brass				
<i>Níquel cepillado</i>	<i>Cobre cepillado</i>	<i>Peltre</i>	<i>Latón antiguo</i>				
0226128Z23	0226128Z26	0226128Z610	0226128Z614	128	137	2	25
0226192Z23	0226192Z26	0226192Z610	0226192Z614	192	201	2	25

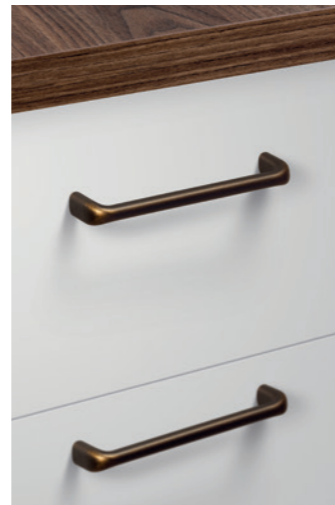

0390 **PETRA** ZAMAK Designer: Viefe Studio

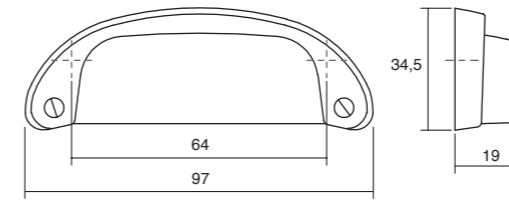

Z66	Z612	ZM2	↓	☐
Antique copper	Antique silver	Matt black		
<i>Cobre antiguo</i>	<i>Plata antigua</i>	<i>Negro mate</i>		
0390064Z66	0390064Z612	0390064ZM2	2	25

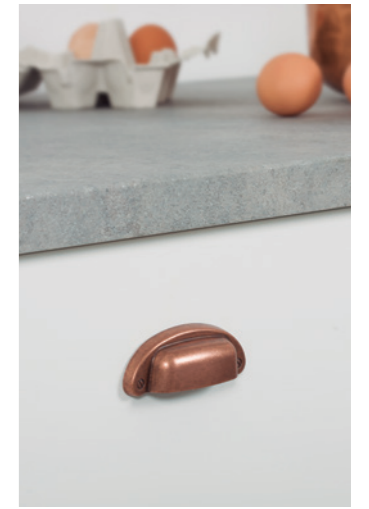

0405 **RAVIOLO** ZAMAK Designer: Balutto Associati

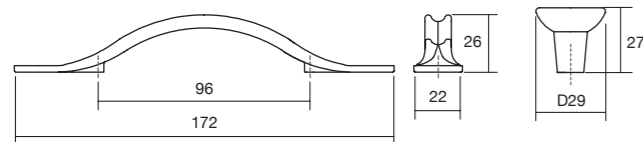

Z610	Z614	↓	☐
Pewter	Antique Brass		
<i>Peltre</i>	<i>Latón antiguo</i>		
0405029Z610	0405029Z614	1	25
0405096Z610	0405096Z614	2	25



0391 **AURA** ZAMAK Designer: Viefe Studio

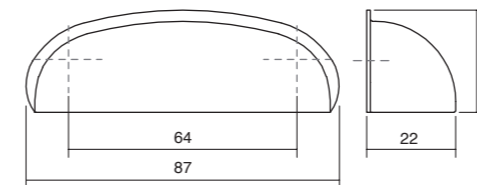

Z66	Z612	↓	☐
Antique copper	Antique silver		
<i>Cobre antiguo</i>	<i>Plata antigua</i>		
0391064Z66	0391064Z612	2	25



0394 **AVA** ZAMAK Designer: Viefe Studio

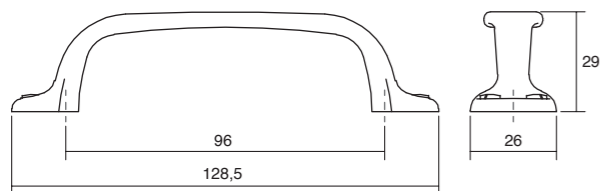

Z610	Z614	↓	☐
Pewter	Antique Brass		
<i>Peltre</i>	<i>Latón antiguo</i>		
0394096Z610	0394096Z614	2	25



0392 **ORION** ZAMAK Designer: Viefe Studio

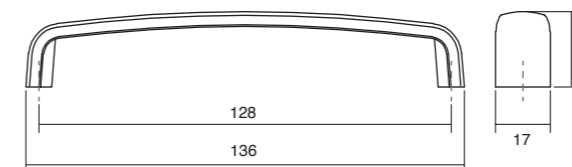

Z66	Z612	↓	☐
Antique copper	Antique silver		
<i>Cobre antiguo</i>	<i>Plata antigua</i>		
0392128Z66	0392128Z612	2	25

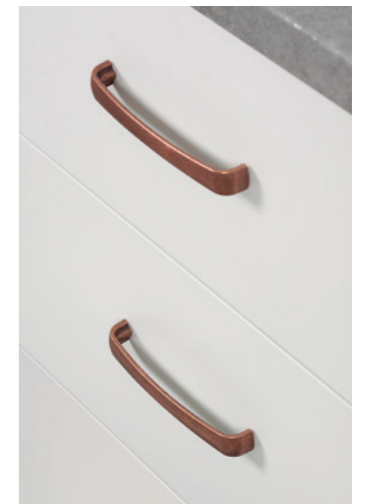

0404 **FLEXA** LEATHER + ZAMAK Designer: Balutto Associati

0404 - 128 / 160

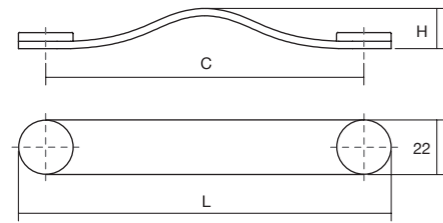

0404 - 070

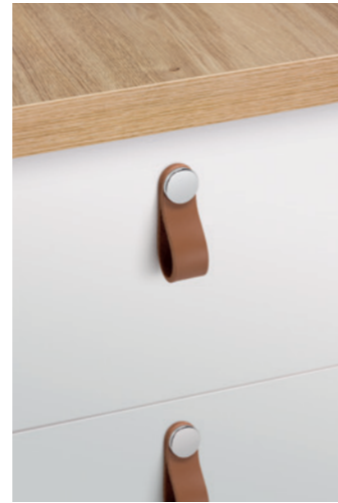
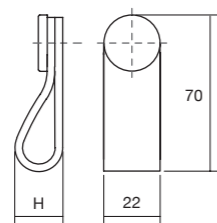

	P26 Beige / Beige	P36 Brown / Marrón	P99 Black / Negro	C	L	H	↓	☐
Z01 Polished chrome / Cromo brillo	0404070P2601	0404070P3601	0404070P9901	-	70	24	1	25
Z01 Polished chrome / Cromo brillo	0404128P2601	0404128P3601	0404128P9901	128	150	25	2	25
Z01 Polished chrome / Cromo brillo	0404160P2601	0404160P3601	0404160P9901	160	182	27	2	25
Z610 Pewter / Peltre	0404070P2610	0404070P3610	0404070P9910	-	70	24	1	25
Z610 Pewter / Peltre	0404128P2610	0404128P3610	0404128P9910	128	150	25	2	25
Z610 Pewter / Peltre	0404160P2610	0404160P3610	0404160P9910	160	182	27	2	25
ZM2 Black / Negro	0404070P26M2	0404070P36M2	0404070P99M2	-	70	24	1	25
ZM2 Black / Negro	0404128P26M2	0404128P36M2	0404128P99M2	128	150	25	2	25
ZM2 Black / Negro	0404160P26M2	0404160P36M2	0404160P99M2	160	182	27	2	25
Z27 Brass / Latón	0404070P2627	0404070P3627	0404070P9927	-	70	24	1	25
Z27 Brass / Latón	0404128P2627	0404128P3627	0404128P9927	128	150	25	2	25
Z27 Brass / Latón	0404160P2627	0404160P3627	0404160P9927	160	182	27	2	25

0340 **BARCCO** WOOD Designer: Alexis Vivet

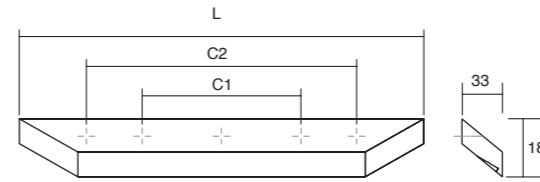

W18 Ash Fresno	W19 Walnut Nogal	W00 Beech raw Haya crudo	C1	C2	L	↓	☐
0340200W18	0340200W19	0340200W00	160	-	200	3	25
0340400W18	0340400W19	0340400W00	320	-	400	3	25
0340600W18	0340600W19	0340600W00	320	480	600	4	25



0165 **CALIN** WOOD Designer: Viefe Studio

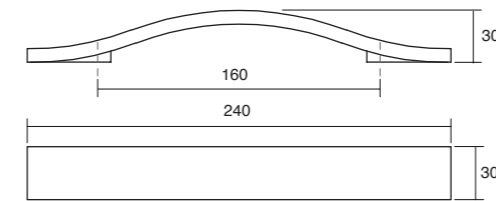

W00 Raw brushed Crudo cepillado	W02 White brushed Blanco cepillado	W08 Brown brushed Marrón cepillado	W09 Black brushed Negro cepillado	↓	☐
0165160W00	0165160W02	0165160W08	0165160W09	2	25



0239 **ARA W** ALUMINIUM + WOOD Designer: 2J Design

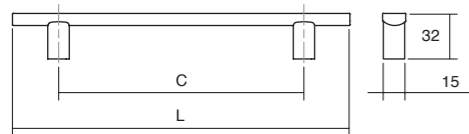

N2416 (L24+W16) Stainless steel look + Oak Inox look + Roble	N2417 (L24+W17) Stainless steel look + Walnut Inox look + Nogal	C	L	↓	☐
0239160N2416	0239160N2417	160	220	2	25
0239224N2416	0239224N2417	224	284	2	25



0166 **ECHO** WOOD Designer: Viefe Studio

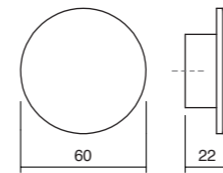

W00 Raw brushed Crudo cepillado	W02 White brushed Blanco cepillado	W08 Brown brushed Marrón cepillado	W09 Black brushed Negro cepillado	↓	☐
0166060W00	0166060W02	0166060W08	0166060W09	1	25





0374 **BALL**

ZAMAK

Designer: Alexis Vivet

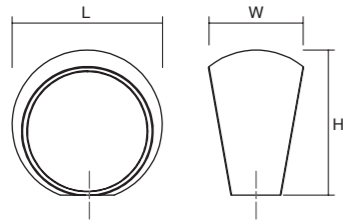

Z01	Z23	Z27	L	W	H	↓	☐
Polished chrome <i>Cromo brillo</i>	Brushed nickel <i>Níquel cepillado</i>	Brushed brass <i>Latón cepillado</i>					
0374024Z01	0374024Z23	0374024Z27	23,3	14,8	22,8	1	25
0374029Z01	0374029Z23	0374029Z27	29,5	18,3	28,8	1	25

0369 **RITTA**

ALUMINIUM

Designer: Teruel & Paré

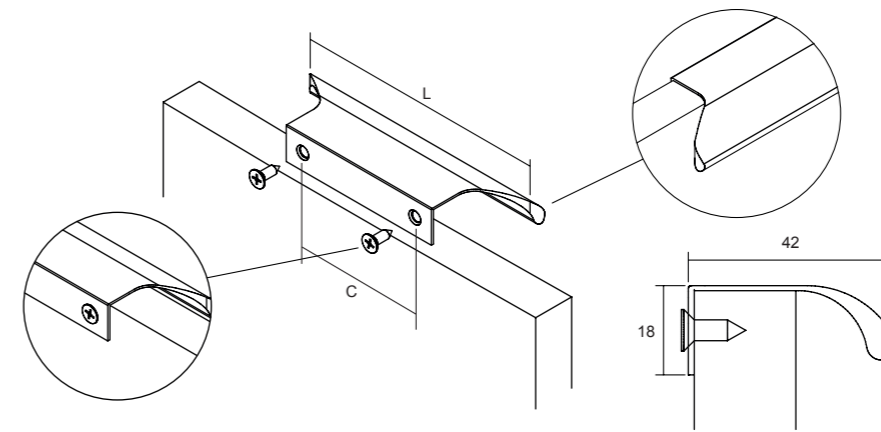

L01	L09	L24	C	L	↓	☐
Polished chrome <i>Cromo brillo</i>	Matt black <i>Negro mate</i>	Stainless steel look <i>Inox look</i>				
0369064L01	0369064L09	0369064L24	64	130	2	25
0369128L01	0369128L09	0369128L24	128	260	2	25

0243 **LOW ST**

ZAMAK

Designer: Viefe Studio

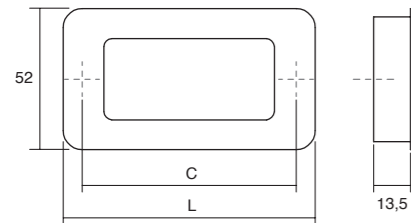

Z23	C	L	↓	☐
Brushed nickel <i>Níquel cepillado</i>				
0243064Z23ST	64	78	2	25 With backplate / Con placa posterior
0243192Z23ST	192	206	2	25 With backplate / Con placa posterior

0091 **RASO**

ZAMAK

Designer: Viefe Studio

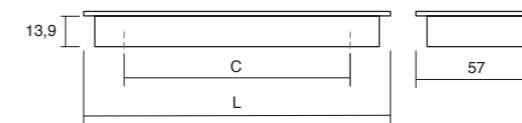

Z23	C	L	↓	☐
Brushed nickel <i>Níquel cepillado</i>				
0091032Z23	32	70	2	25
0091108Z23	108	152,5	2	25

0281 **FLAT**

ZAMAK

Designer: Oriol Barri

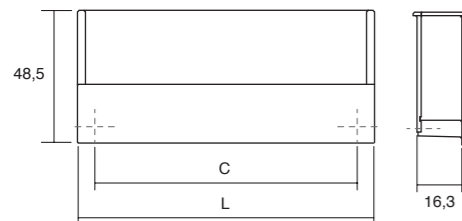

Z23	C	L	↓	☐
Brushed nickel <i>Níquel cepillado</i>				
0281160Z23	160	174,8	2	25

0376 **BOXX**

ZAMAK

Designer: Alexis Vivet

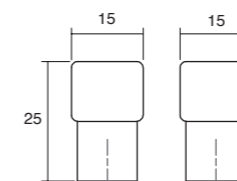

Z01	Z11	Z23	ZM2	↓	☐
Polished chrome <i>Cromo brillo</i>	Matt chrome <i>Cromo mate</i>	Brushed nickel <i>Níquel cepillado</i>	Matt black <i>Negro mate</i>		
0376012Z01	0376012Z11	0376012Z23	0376012ZM2	1	25

0064 **KOMBI** STAINLESS STEEL Designer: Viefe Studio

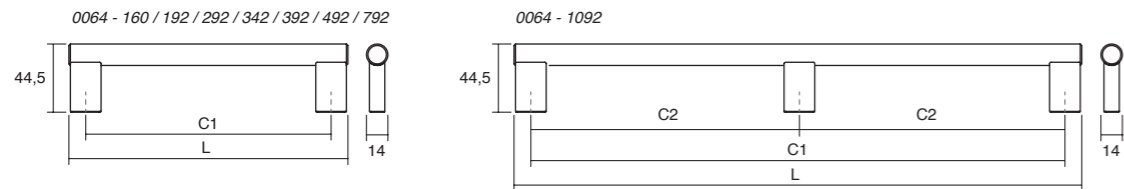

**S25**  
Brushed stainless steel  
*Inox cepillado*

	C1	C2	L	↓	☐
0064160S25	160	-	182	2	25
0064192S25	192	-	214	2	25
0064292S25	292	-	314	2	25
0064342S25	342	-	364	2	25
0064392S25	392	-	414	2	25
0064492S25	492	-	514	2	25
0064792S25	792	-	814	2	10
00641092S25	1092	546	1114	3	10



6005 **FONDA** ALUMINIUM Designer: Viefe Studio

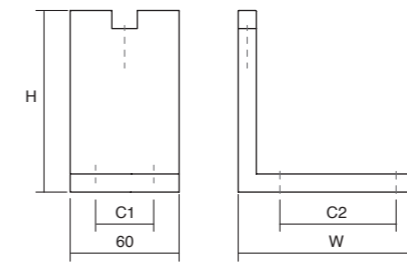

L01	L24	L29	L30	C1	C2	W	H	↓	☐
Polished chrome <i>Cromo brillo</i>	Stainless steel look <i>Inox look</i>	Brushed dark brass <i>Latón oscuro cepillado</i>	Brushed black <i>Negro cepillado</i>						
6005100L01	6005100L24	6005100L29	6005100L30	32	44	80	100	4	24
6005150L01	6005150L24	6005150L29	6005150L30	32	44	80	150	4	24
6005200L01	6005200L24	6005200L29	6005200L30	32	64	100	200	4	24



0312 **ARKO** ALUMINIUM Designer: Viefe Studio

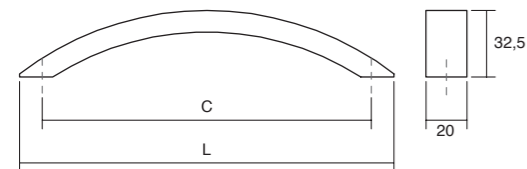

**L24**  
Stain. steel look  
*Inox look*

	C	L	↓	☐
0312160L24	160	186	2	25
0312192L24	192	218	2	25
0312256L24	256	292	2	25



0035 **ACER** STAINLESS STEEL Designer: 2J Design

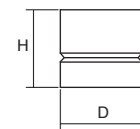

**S25**  
Brushed stain. steel  
*Inox cepillado*

	D	H	↓	☐
0035018S25	18	23	1	25
0035023S25	23	25	1	25
0035028S25	28	27	1	25



# Finishes

## ZAMAK

### Glossy Brillante

-  **Z01**  
Polished chrome  
*Cromo brillo*
-  **Z03**  
Polished titanium black  
*Titanio negro brillo*
-  **Z05**  
Polished nickel  
*Níquel brillo*
-  **Z06**  
Polished copper  
*Cobre brillo*
-  **Z07**  
Polished brass  
*Latón brillo*

### Grey Gris

-  **Z11**  
Matt chrome  
*Cromo mate*
-  **Z31**  
Brushed grey  
*Gris cepillado*
-  **Z32**  
Brushed mole grey  
*Gris topo cepillado*
-  **Z617**  
Graphite grey  
*Gris grafito*
-  **ZP1**  
Chrome look  
*Look cromo*

### Brass Latón

-  **Z27**  
Brushed brass  
*Latón cepillado*
-  **Z28**  
Brushed gold  
*Oro cepillado*
-  **Z618**  
Brushed brass cava  
*Latón cava cepillado*

### Black Negro

-  **ZM2**  
Matt black  
*Negro mate*
-  **Z33**  
Titanium black  
*Negro titanio*

### Color Color

-  **ZM25**  
Moss grey  
*Gris musgo*
-  **ZM31**  
Forest green  
*Verde forest*
-  **ZM41**  
Metallic brown  
*Marrón metal*
-  **ZM43**  
Mocca brown  
*Marrón mocca*
-  **ZM72**  
Volcano red  
*Rojo volcanico*

### White Blanco

-  **ZM1**  
Matt white  
*Blanco mate*

### Copper Cobre

-  **Z26**  
Brushed copper  
*Cobre cepillado*

### Inox look Look inox

-  **Z23**  
Brushed nickel  
*Níquel cepillado*

### Vintage Vintage

-  **Z66**  
Antique copper  
*Cobre antiguo*
-  **Z610**  
Pewter  
*Peltre*
-  **Z612**  
Antique silver  
*Plata antigua*
-  **Z614**  
Antique brass  
*Latón antiguo*
-  **Z623**  
Rustic brass  
*Latón rústico*
-  **ZM22**  
Textured black  
*Negro texturizado*

### IMPORTANT NOTE:



The finishes that you see represented in this section are a digital simulation of the real finishes and in no way can they be used as a reference for physical comparisons. The aim of this index is to guide and inform the user about the finishes we work with. The finishes of all our models are defined exactly as is indicated in the catalogue and therefore are in no way characteristics that can be personalized.

### NOTA IMPORTANTE:

Los acabados representados en esta sección son una simulación digital de los acabados reales y en ningún caso se pueden utilizar como referencia para comparativas físicas. Este índice se debe utilizar únicamente como orientación para conocer los acabados con los que trabaja Pedenetti. Todos los diseños de Pedenetti tienen sus acabados definidos tal como indica el catálogo y, por lo tanto, no es una característica personalizable en ningún caso.

## ALUMINIUM

### Glossy Brillante

-  **L01**  
Polished chrome  
*Cromo brillo*
-  **L02**  
Anodized bright  
*Anodizado brillo*

### Grey Gris

-  **L04**  
Anodized matt  
*Anodizado mate*
-  **L31**  
Brushed grey  
*Gris cepillado*
-  **LM23**  
Metallic grey  
*Gris metal*

### White Blanco

-  **LM1**  
Matt white  
*Blanco mate*

### Brass Latón

-  **L29**  
Brushed dark brass  
*Latón oscuro cepillado*
-  **L291**  
Brushed brass  
*Latón cepillado*
-  **L618**  
Brushed brass cava  
*Latón cava cepillado*

### Black Negro

-  **L09 / LM2**  
Matt black  
*Negro mate*
-  **L30**  
Brushed black  
*Negro cepillado*

### Color Color

-  **LM41**  
Metallic brown  
*Marrón metal*
-  **LM25**  
Moss grey  
*Gris musgo*
-  **LM31**  
Forest green  
*Verde forest*
-  **LM43**  
Mocca brown  
*Marrón mocca*
-  **LM72**  
Volcano red  
*Rojo volcanico*
-  **LM82**  
Midnight blue  
*Azul midnight*

### Stainless steel look Look inox

-  **L24**  
Stainless steel look  
*Inox look*

### Vintage Vintage

-  **L613**  
Antique bronze  
*Bronce antiguo*
-  **L623**  
Rustic brass  
*Latón rústico*

## STAINLESS STEEL

-  **S25**  
Brushed stainless steel  
*Inox cepillado*

## WOOD

-  **W00**  
Raw brushed  
*Crudo cepillado*
-  **W02**  
White brushed  
*Blanco cepillado*
-  **W08**  
Brown brushed  
*Marrón cepillado*
-  **W09**  
Black brushed  
*Negro cepillado*
-  **W16**  
Oak  
*Roble*
-  **W17**  
Walnut  
*Nogal*
-  **W18**  
Ash  
*Fresno*
-  **WM2**  
Wood matt black  
lacquered  
*Madera lacada  
negra mate*

## LEATHER

-  **P26**  
Beige  
*Beige*
-  **P36**  
Brown  
*Marrón*
-  **P99**  
Black  
*Negro*

Number	Model	Product pag	Tech info pag
0035	<b>ACER</b>	283	338
0077	<b>ANGLE</b>	146 - 149	323
0239	<b>ARA W</b>	272 - 273	334
0206	<b>ARCH</b>	282	323
0312	<b>ARKO</b>	281	338
0583	<b>ARPA</b>	108 - 113	307
0588	<b>ARPA PLATE</b>	104 - 107	306
0219	<b>ARROW</b>	279	331
0391	<b>AURA</b>	269	333
0394	<b>AVA</b>	266	332
0374	<b>BALL</b>	277	336
0340	<b>BARCCO</b>	274 - 275	335
0496	<b>BAU</b>	152 - 153	308
0447	<b>BELLA</b>	208 - 209	318
0590	<b>BELT</b>	66 - 69	297
0489	<b>BOL</b>	182 - 183	311
0376	<b>BOXX</b>	280	337
0452	<b>BRAVE</b>	232 - 233	324
0334	<b>BRIKK</b>	250 - 251	329
0410	<b>BUTTON</b>	258 - 259	331
0165	<b>CALIN</b>	276	335
0235	<b>CLOS</b>	220 - 221	320
0168	<b>COMO</b>	158 - 161	310
0538	<b>CONIC wood</b>	124 - 125	303
0538	<b>CONIC zamak</b>	126 - 127	304
0366	<b>CUBIC</b>	222 - 223	320
0117	<b>CURVE</b>	240 - 241	327
0322	<b>CUTT</b>	256 - 257	324
0497	<b>DIABOLO</b>	162 - 163	310
0053	<b>DINO</b>	252 - 253	326
0556	<b>DIPO</b>	138 - 139	304
0530	<b>DISC wood</b>	120 - 121	303
0530	<b>DISC zamak</b>	122 - 123	303
0393	<b>DUKE</b>	260 - 261	331
0659 / 0668 / 0670	<b>DUO BIG NEW!</b>	50 - 51	294
0658	<b>DUO MINI NEW!</b>	48 - 49	294
0166	<b>ECHO</b>	277	335
0614	<b>EQUIS</b>	96 - 97	302
0446	<b>ESTE</b>	206 - 207	314
0591	<b>ETO</b>	84 - 87	299
0451	<b>FELTRE</b>	230 - 231	318
0506	<b>FIRM</b>	114 - 119	315
0610	<b>FLAPP aluminium</b>	76 - 79	299
0613	<b>FLAPP wood</b>	80 - 83	300
0281	<b>FLAT</b>	278	336
0404	<b>FLEXA</b>	270 - 271	334
0495	<b>FLOID</b>	150 - 151	308
0542	<b>FOLD</b>	128 - 131	306
6005	<b>FONDA</b>	284 - 285	339
0250 / 0251	<b>FORMA</b>	249	329
0627	<b>FUSION NEW!</b>	18 - 21	288
0343	<b>GRADA</b>	246 - 247	330
0109	<b>GRAF</b>	202 - 203	318
0486	<b>GRAF BIG</b>	194 - 199	317
0430	<b>GRAF MINI</b>	200 - 201	317
0449	<b>HEXXA</b>	210 - 213	319
0094	<b>HIDE</b>	214 - 215	316
0127	<b>JEY</b>	154 - 157	309

0163	<b>JEY2</b>	156 - 157	309
0162	<b>KADO</b>	282	322
0064	<b>KOMBI</b>	283	338
0494	<b>LAND</b>	186 - 189	314
0635	<b>LIDD NEW!</b>	22 - 23	289
0139 / 0140	<b>LINEAR</b>	242 - 243	327
0459	<b>LINES</b>	204 - 205	315
0643	<b>LINKK NEW!</b>	26 - 29	290
0603	<b>LIPP NEW!</b>	34 - 35	291
0243 ST	<b>LOW ST</b>	278	336
0536	<b>LUV</b>	56 - 57	295
0664 / 0665 / 0671	<b>LUV WOOD NEW!</b>	52 - 55	295
0629 / 0662 / 0663	<b>MOON NEW!</b>	44 - 47	293
0650	<b>MOULE NEW!</b>	32 - 33	291
0105	<b>NEST</b>	218 - 219	320
0373	<b>NICK</b>	254 - 255	322
0657	<b>NOBB NEW!</b>	40 - 43	293
0254 / 0255	<b>NOMA</b>	144 - 145	328
0507	<b>OBLONG</b>	184 - 185	313
0601	<b>OH! wood</b>	88 - 89	300
0601	<b>OH! zamak</b>	90 - 91	301
0648	<b>OMEGA NEW!</b>	30 - 31	290
0372	<b>ONA</b>	140 - 143	326
0392	<b>ORION</b>	268	333
0553	<b>OTO</b>	136 - 137	305
0444	<b>PEAK</b>	234 - 235	325
0516	<b>PENDANT</b>	190 - 193	316
0390	<b>PETRA</b>	267	333
0597	<b>PLIÉ</b>	70 - 71	298
0636	<b>POINT NEW!</b>	14 - 17	288
0638	<b>PRISM NEW!</b>	24 - 25	289
0604	<b>PRISMA</b>	98 - 99	301
0487	<b>PURA</b>	62 - 65	297
0616	<b>QUART big</b>	102 - 103	302
0608	<b>QUART mini</b>	100 - 101	302
0511	<b>RAIL</b>	170 - 173	312
0091	<b>RASO</b>	281	337
0405	<b>RAVILOLO</b>	264 - 265	332
0226	<b>REDO</b>	262 - 263	332
0528	<b>RILLE</b>	60 - 61	296
0621	<b>RILLE MINI NEW!</b>	58 - 59	296
0552	<b>RIM</b>	134 - 135	305
0645	<b>RISS MINI NEW!</b>	36 - 37	292
0655	<b>RISS BIG NEW!</b>	38 - 39	292
0369	<b>RITTA</b>	279	337
0241	<b>ROMA</b>	178 - 181	313
0499	<b>ROUND</b>	164 - 165	310
0195	<b>SENSE</b>	228 - 229	321
0301	<b>SENSE MINI</b>	226 - 227	321
0543	<b>SOFT</b>	132 - 133	304
0380	<b>STEEP</b>	248	330
0073	<b>TAP</b>	224 - 225	321
0056	<b>U</b>	174 - 177	312
0602	<b>VALLEY</b>	92 - 95	301
0375	<b>VANN</b>	236 - 239	325
0434	<b>VECTOR</b>	244 - 245	328
0119	<b>WAVE</b>	216 - 217	319
0518	<b>WAY</b>	166 - 169	311
0600	<b>WING</b>	72 - 75	298



[pedenetti.com](https://pedenetti.com)

[info@pedenetti.com](mailto:info@pedenetti.com)  
**T +34 956 530 466**

Polígono Industrial El torno  
Avda. de la Industria, 52.  
Chiclana de la Frontera (11130)  
Cádiz. Spain



20  
24



---

**HANDLES & KNOBS  
CATALOGUE**

 **pedenetti.com**